

2022  
ürün  
katalogu

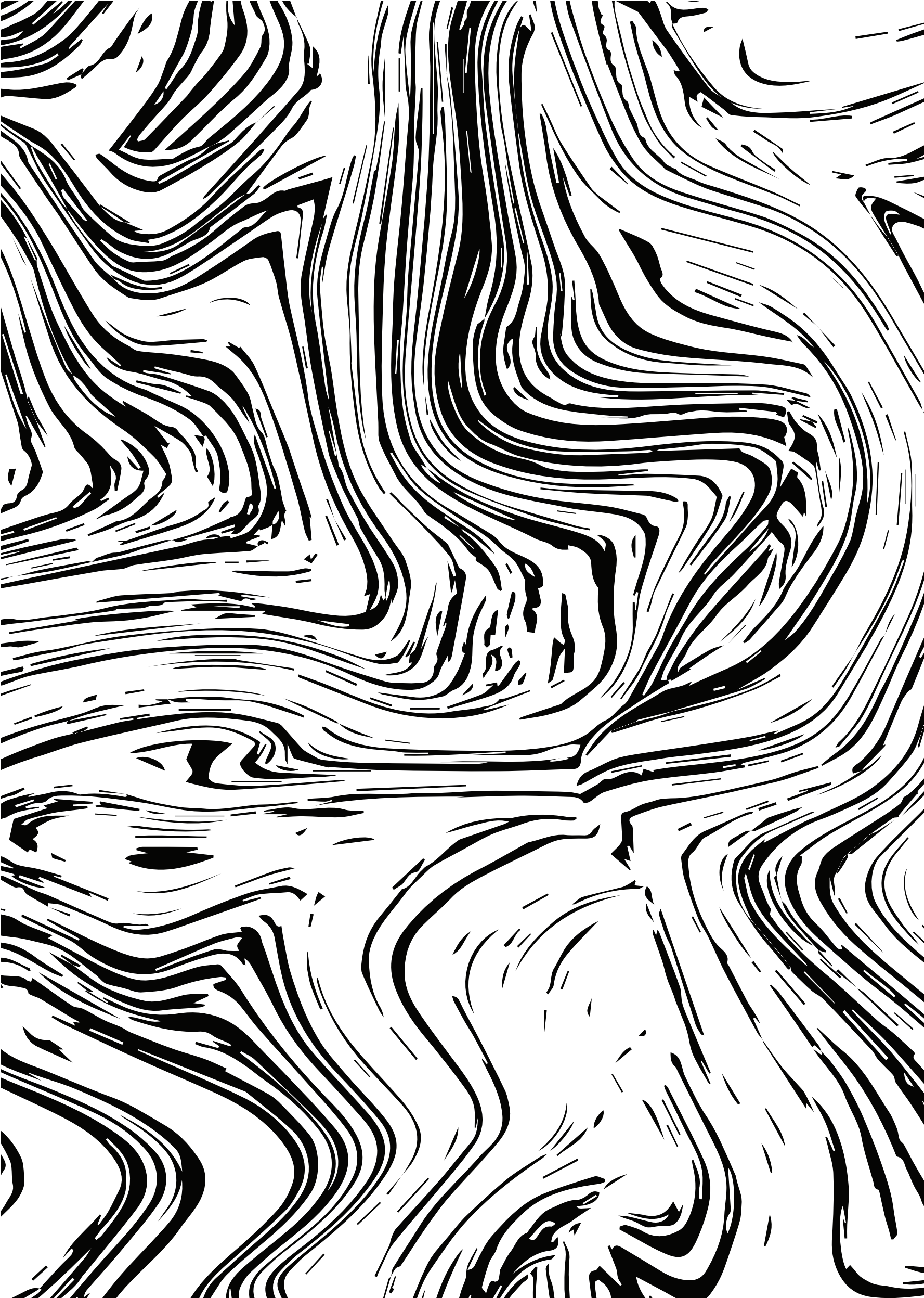

[www.nilperde.com](http://www.nilperde.com) • [www.nilray.com](http://www.nilray.com)





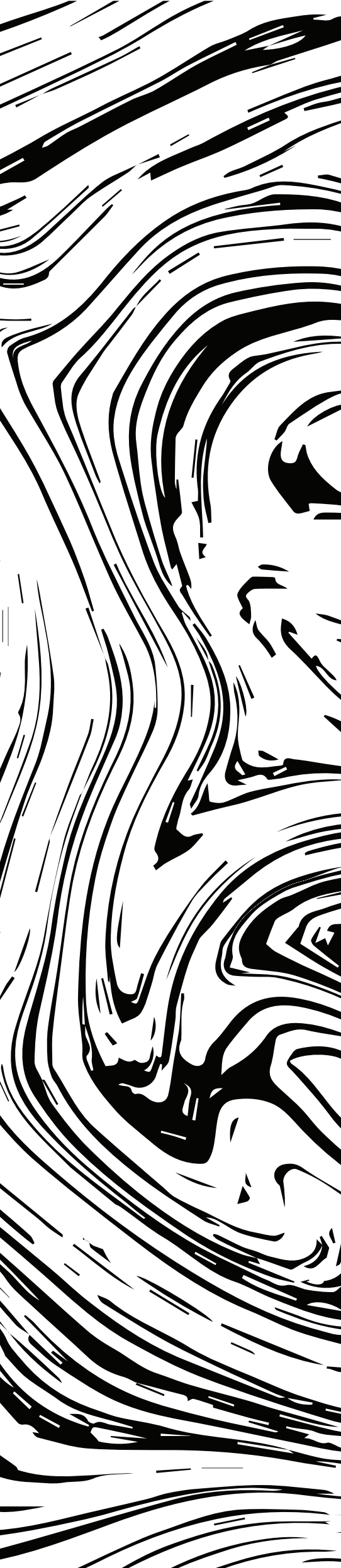

# Hakkımızda

Firmamız 2006 Yılından bu yana Otel, Hastane, Ofis ve Ev Tekstili alanlarında sıra dışı ürünleriyle yenilikler sunmaktadır. Amacımız ürün ve hizmetlerimizle konforlu, sağlıklı, huzurlu yaşayabileceğiniz alanlar oluşturmaktır. Yurtiçi ve yurtdışı pazardaki faaliyetlerimiz ile müşteri beklentilerine en uygun çözümleri imalatçı ve uygulayıcı kimliğimizle sunmaktayız. Kurumsal, bireysel ve butik projelerde müşterilerimize daima kaliteli, ekonomik, hızlı, güler yüzlü hizmet sunmayı prensip edinmiş bir kuruluşuz. Tüm ilişkilerimizde karşılıklı yarar sağlamak, Katma değer üretmek amacı ile iyi niyet ve anlayışla davranmak, yasalara ve iş ahlakına daima bağlı kalmak ilkemizdir.

# Vizyonumuz

Enerji ve çevreyi; ilerleme ve gelişmenin bir parçası görerek, sektöründe kıyas kabul edilen ve tüm paydaşları için değer üreten bir firma olmaktır.

# Misyonumuz

Hizmet ağımıza dahil olmuş ve olacak tüm müşterilerimize sosyal ve hukuki sorumluluklarımızın bilincinde, çevreye saygılı, insan odaklı, güvenli, kaliteli ve sürekli hizmeti sunmaktır.

# İçindekiler

05 / 09	• NL 2001 Serisi Alüminyum Raylar
10 / 13	• NL 4001 Hastane Ray Sistemi
14 / 16	• NL 3001 Paslanmaz Seperatör Perde
17 / 20	• NL 12001 Katlamalı Perde Mekanizması
21	• NL 6001 Oryantal Raylar
22 / 24	• NL 11001 Dekoratif Raylar
25 / 26	• NL 15001 Alınlıklı 2'li Ray;
27 / 28	• NL 14100 Alınlık
29 / 34	• NL 19001 Dekoratif Raylı Rustik
35 / 37	• NL 17001 Motorlu Sahne Rayı
38	• NL 17200 Winter Garden Kış Bahçesi
39 / 41	• NL 1001 Yanmaz, Antibakteriyel ve Su Geçirmez Hastane Perdeleri
42 / 43	• NL 7001 Banyo Ray Sistemi
44 / 47	• NL 8001 Banyo Boruları ve Perdesi
48 / 51	• NL 18001 Ahşap Rustikler
52 / 55	• NL 250001 Alüminyum Metal Rustik
56 / 61	• NL 30001 Alüminyum Metal Rustik
62 / 72	• NL 9001 Paslanmaz Metal Çelik Rustikler
73 / 74	• NL 24001 Ahşap Jaluzi
75 / 76	• NL 26001 Metal Jaluzi
77 / 79	• NL 23001 Dikey Pvc ve Kumaş Perde
80 / 82	• NL 22001 Stor ve Zebra Perdeler
83 / 84	• NL 27001 Plise Perdeler
85	• NL 21100 Metal Briz Çubukları
86 / 91	• Perde Aksesuarları
92 / 94	• Sertifikalar



# NL 2001

Serisi  
Alüminyum  
Raylar



NL 2001  
Tekli Rulmanlı  
Ray



NL 2001  
Oval Büküm







**NL 2003**  
Alüminyum 3'lü Ray



**NL 2002**  
Alüminyum 2'li Ray



**NL 2010**  
Beyaz Yandan Çıkmalı Tekli Ray



**NL 2010**  
Gümüş Yandan Çıkmalı Tekli Ray



**NL 2010**  
Siyah Yandan Çıkmalı Tekli Ray



**NL 2010**  
Oval Büküm



**NL 2010**  
Köşe Büküm



**NL 2020**  
Alüminyum Potraylı  
Tekli Ray



**NL 2025**  
Es Pile Tekli Ray



**NL 2020**  
Köşe Büküm



**NL 2020**  
Oval Büküm



NL 2050  
Gold



NL 2050  
Siyah



NL 2050  
İnoks



NL 2050  
Gümüş



NL 2050  
Köşe Büküm



NL 2050  
Oval Büküm







# NL 4001

Hastane  
Ray Sistemi







NL 4100  
Beyaz



NL 4100  
Gold



NL 4100  
Gümüş



NL 4100  
Siyah



NL 4111  
T Aparatı



NL 4010  
Ek Birleştirme



NL 4006  
Sıfır Tavan Aparatı



NL 4100  
Köşe Büküm



NL 4100  
Oval Büküm



NL 4005  
Askı Çubuğu



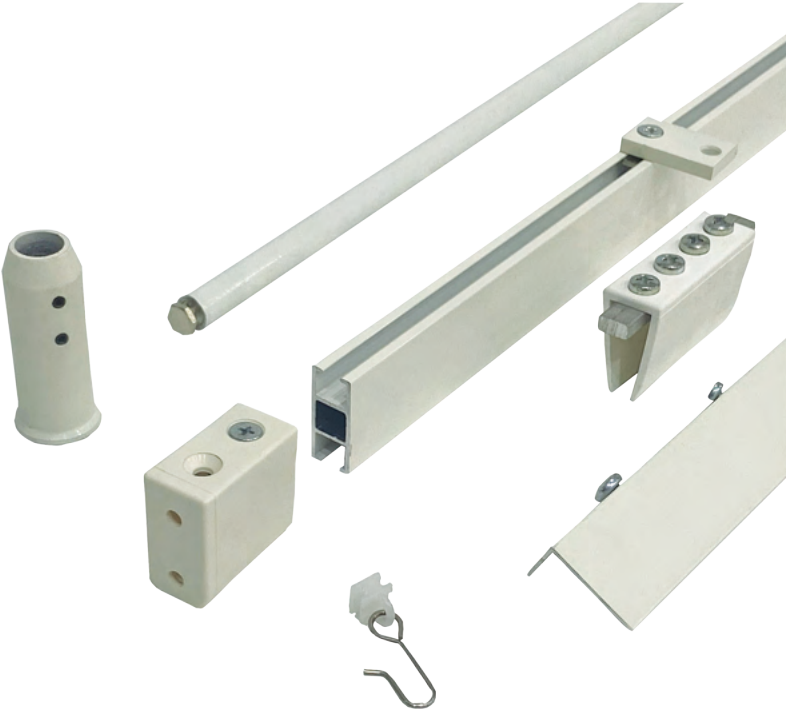

NL 4100  
Beyaz Takım

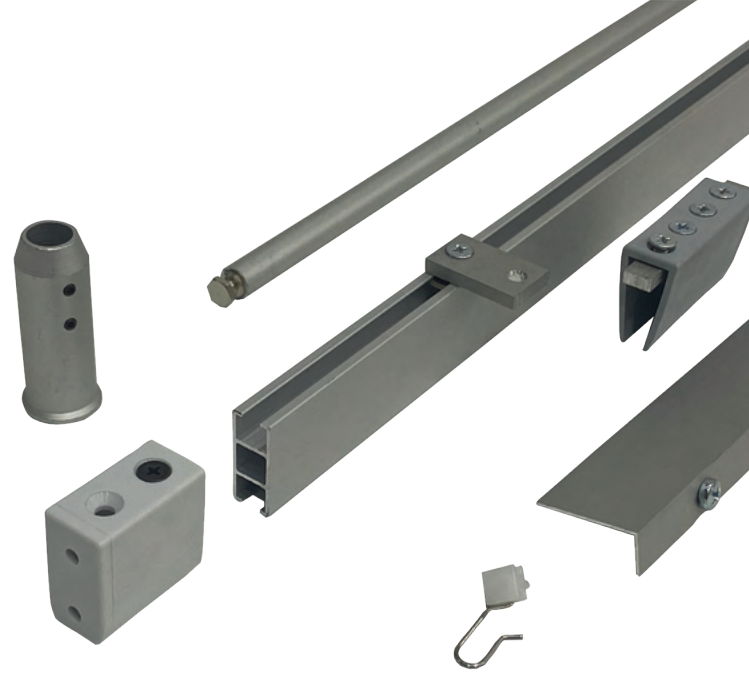

NL 4100  
Gümüş Takım

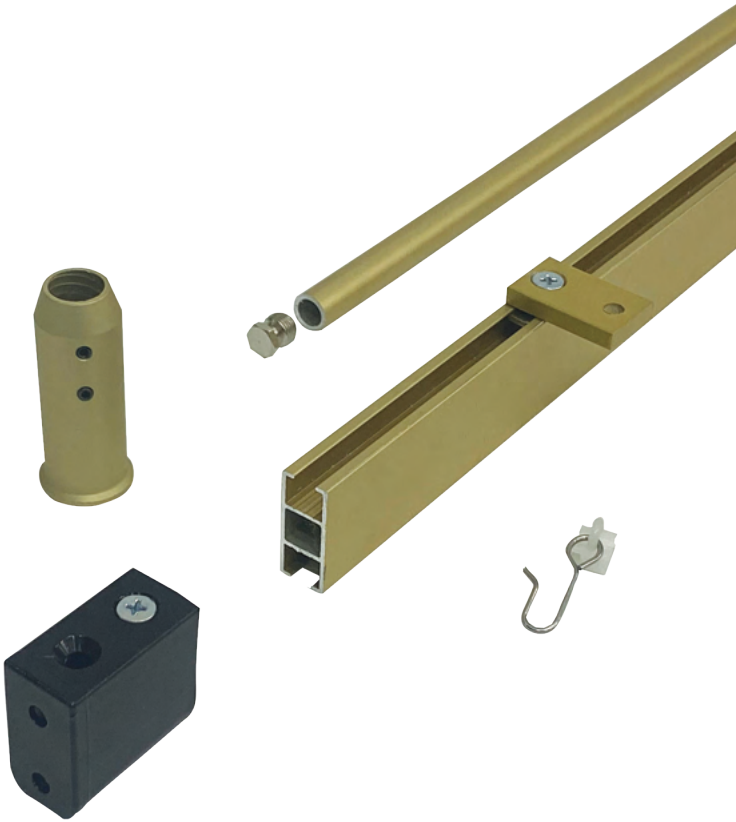

NL 4100  
Gold Takım



NL 4100  
Siyah Takım

Teknik Çizimler

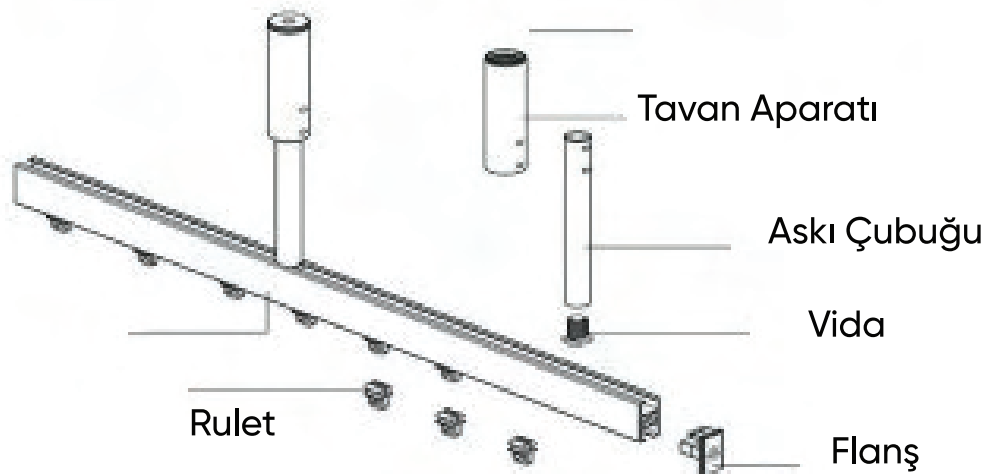
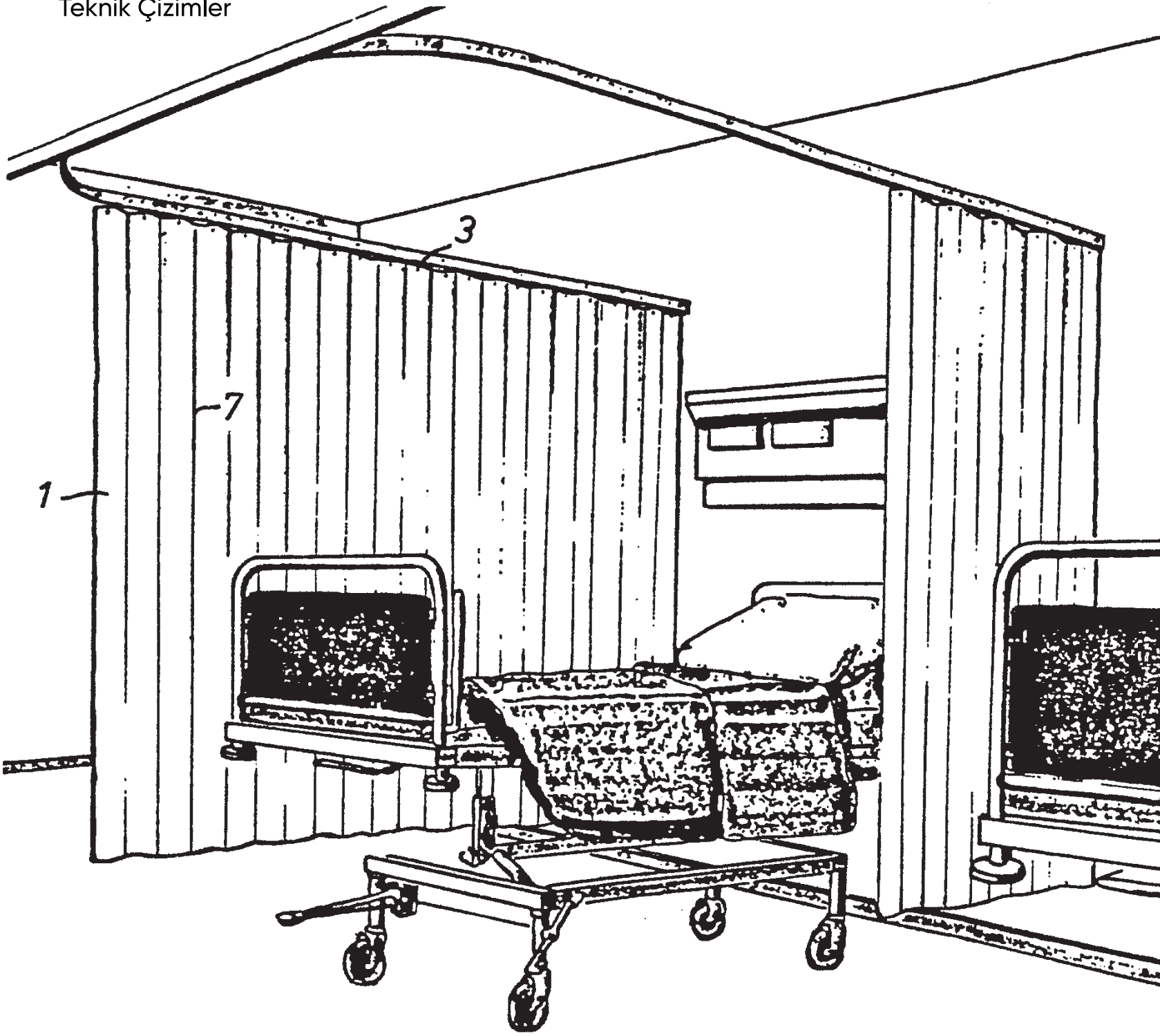





# NL 3001

Paslanmaz  
Seperatör Perde



Ön  
NL 3100



NL 3100  
Arka



NL 3100  
Tij







NL 13100  
Beyaz İnce Trajlı



NL 13200  
Kalın Trajlı Ray

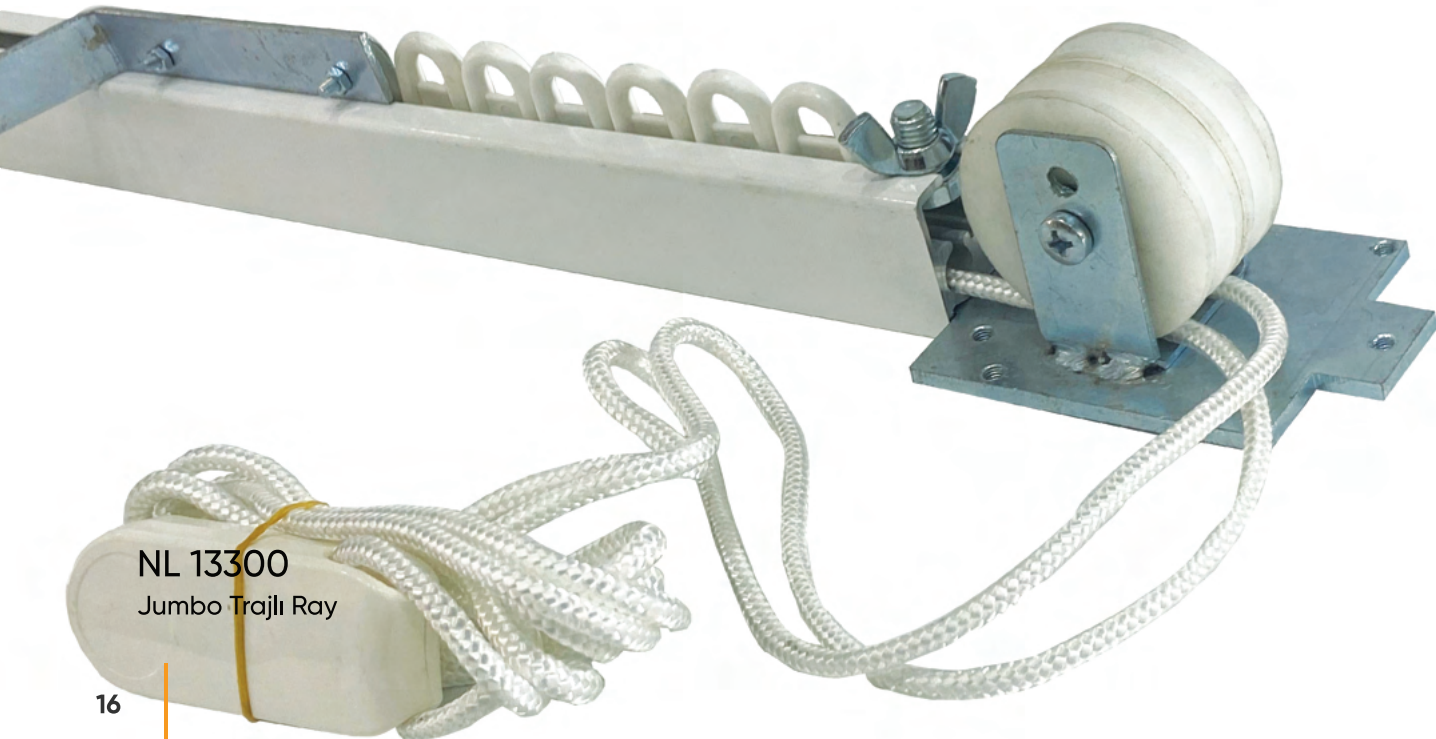

NL 13300  
Jumbo Trajlı Ray



# NL 12001

Katlamalı Perde  
Mekanizması





NL 12100  
Kapalı Kasa  
Katlama  
Mekanizması

**NL 12200**

Beyaz Geniř Kasa  
Katlama  
Mekanizması  
5+1



**NL 12200**

Krem Geniř Kasa  
Katlama  
Mekanizması  
5+1





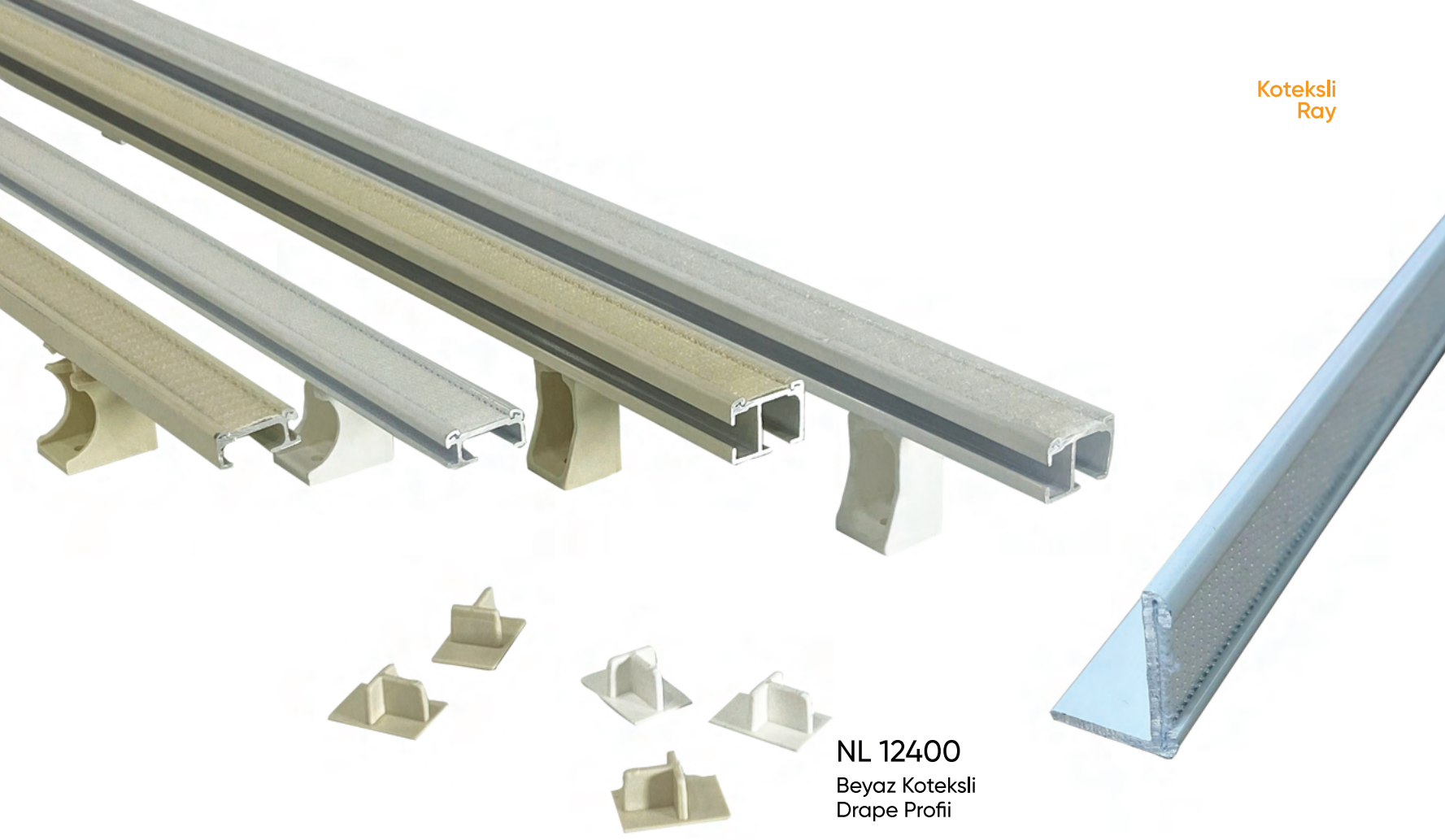

NL 12400  
Beyaz Kotekli  
Drape Profi



NL 12300  
Beyaz Dar Kasa  
Kotekli Ray

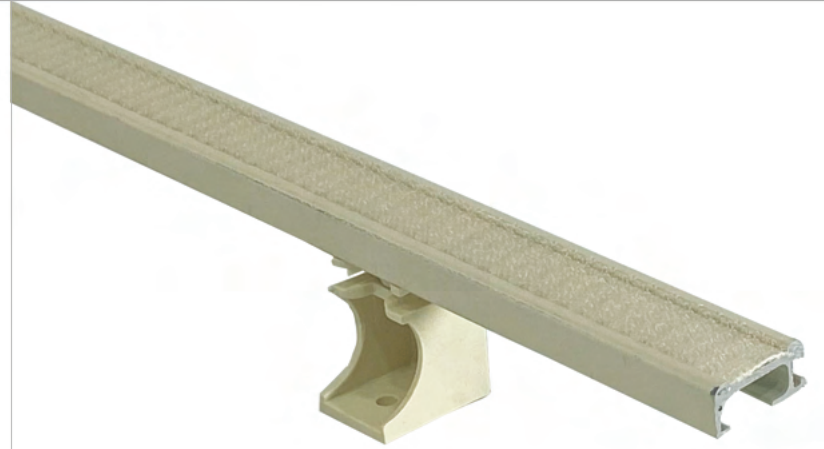

NL 12300  
Krem Dar Kasa  
Kotekli Ray



NL 12300  
Beyaz Geniş Kasa  
Kotekli Ray



NL 12300  
Krem Geniş Kasa  
Kotekli Ray

# NL 6001

## Oryantal Ray



NL 6101



NL 6102



NL 6103







# NL 11001

Dekoratif  
Raylar



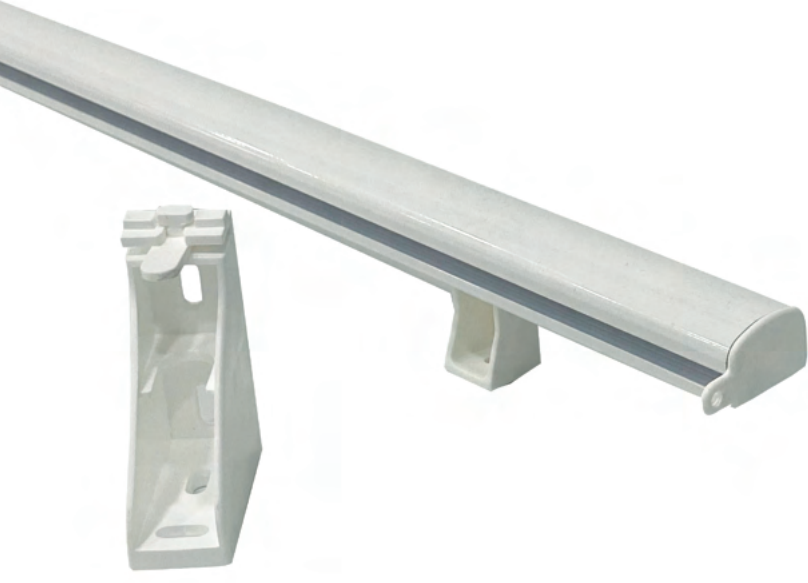

NL 11100  
Beyaz



NL 11100  
Gümüş



NL 11100  
İnoks



NL 11100  
Siyah



NL 11200  
Beyaz



NL 11200  
Gold



NL 11200  
Gümüş



NL 11200  
İnoks



NL 11200  
Siyah







NL 15001

Alınlıklı  
2'li Ray



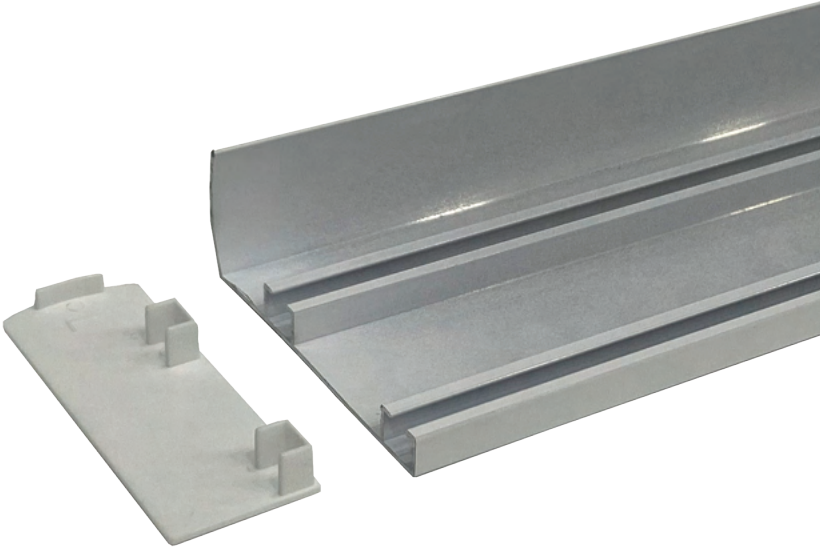

NL 15100  
Beyaz

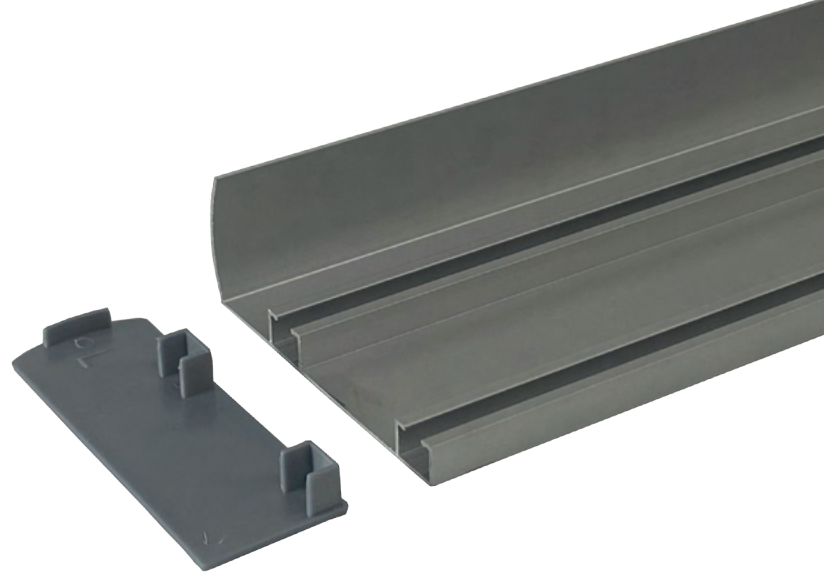

NL 15100  
Gümüş



NL 15100  
İnoks



NL 15100  
Siyah





NL 14100  
Alınlık



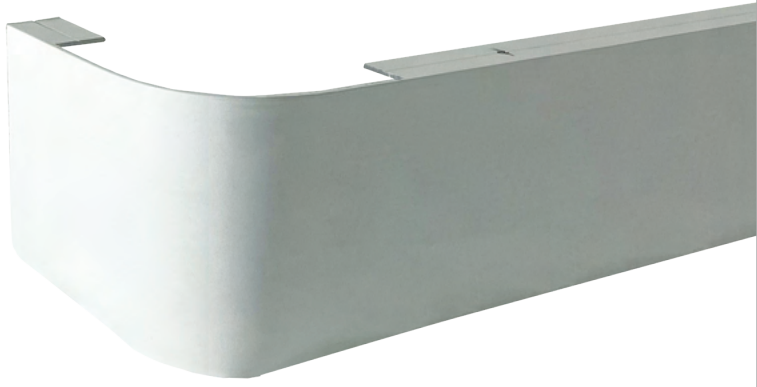

NL 14100  
Beyaz

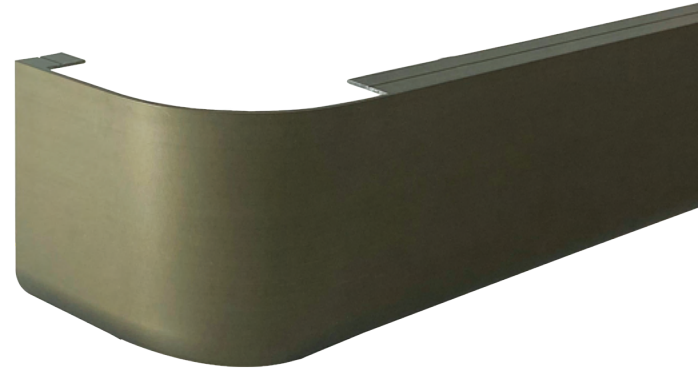

NL 14100  
Bronz



NL 14100  
Gümüş



NL 14100  
İnox

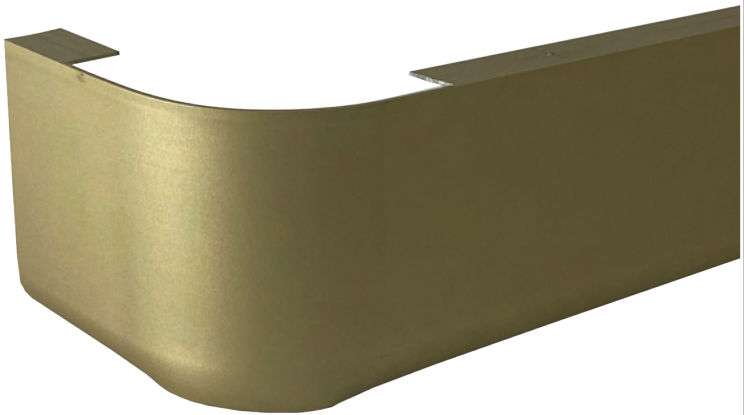

NL 14100  
Gold



Uygulama  
Örnekleri



The image shows a pair of light beige curtains hanging from a silver decorative rod. The curtains have a series of vertical pleats and are tied back with a thick, braided rope. The background is a plain, light-colored wall.

# NL 19001

Dekoratif Raylı  
Rustik





NL 19100  
Gold



NL 19100  
Gümüş



NL 19100  
İnoks



NL 19100  
Krem



NL 19100  
Siyah



Renso



NL 19200  
Siyah

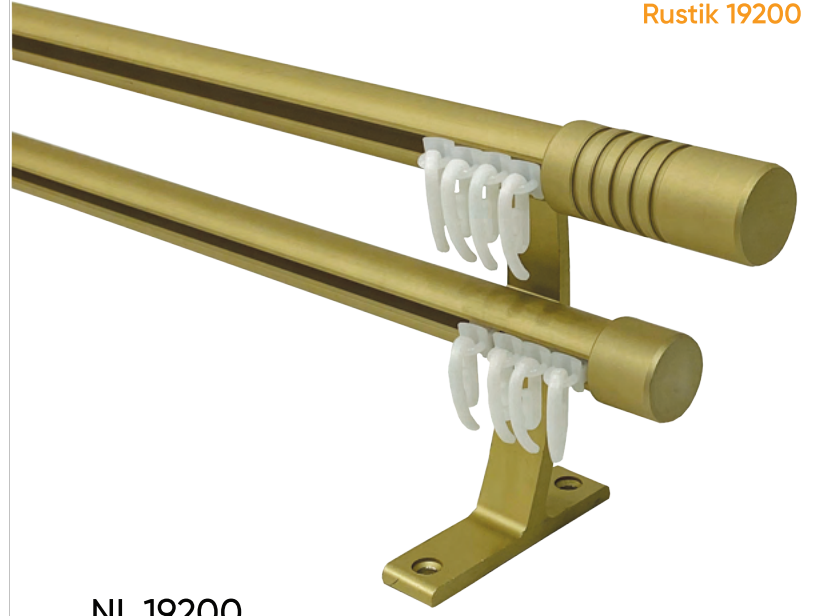

NL 19200  
Gold



NL 19200  
İnoks

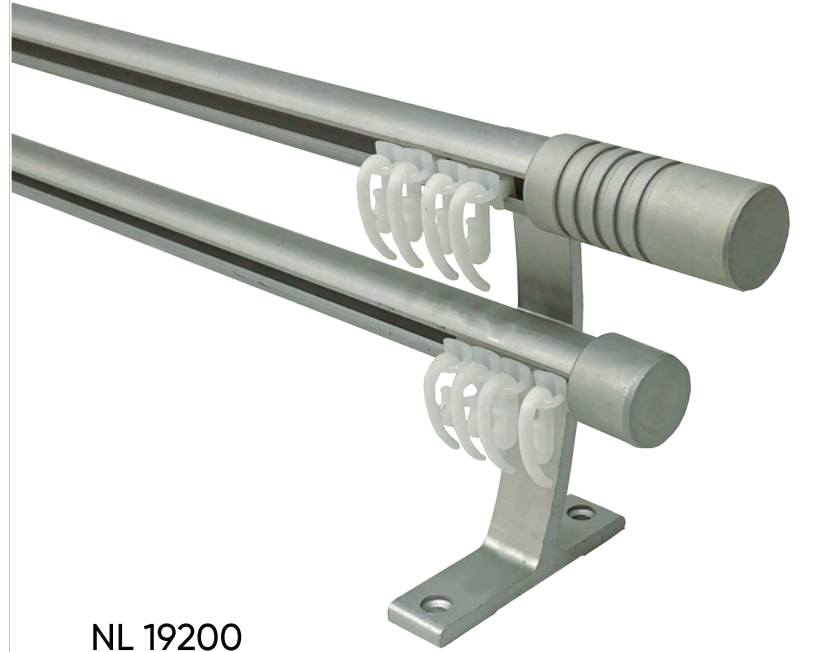

NL 19200  
Gümüş



NL 19200  
Krem

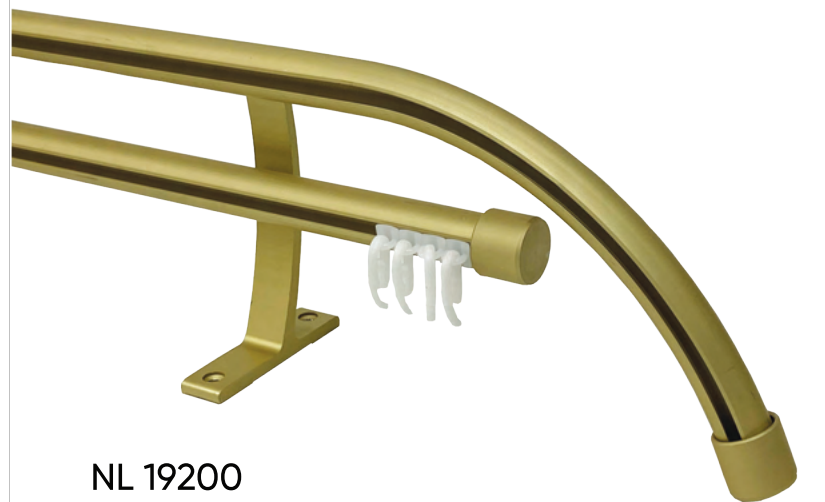

NL 19200  
Eğimli Model



NL 19300 Dekoratif  
Tekli ve Çiftli Rustik

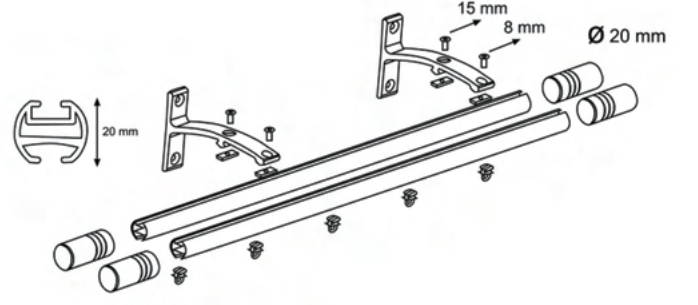

Teknik Çizim

NL 19300  
Gold



NL 19300  
İnoks



NL 19300  
Gümüş



NL 19300  
Krem



NL 19300  
Siyah



NL 16100  
Gold



NL 16100  
Gümüş



NL 16100  
İnoks



NL 16100  
Siyah





NL 16200  
İnoks



NL 16200  
Gold



NL 16200  
Gümüş

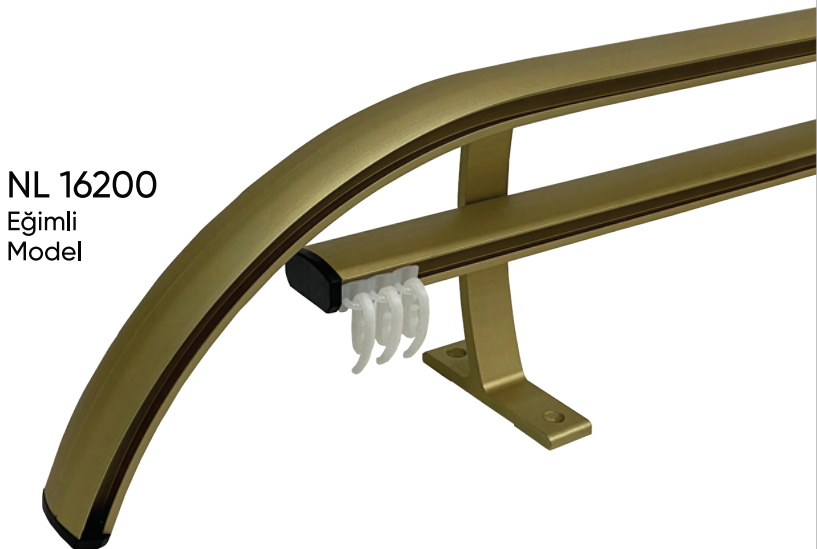

NL 16200  
Eğimli  
Model



NL 16200  
Siyah



NL 17001 Motorlu  
Sahne Rayi

# NL 17001

Motorlu Sahne  
Rayi

**MOSEL**<sup>®</sup>



# Sahne Rayı





NL 17001  
Oval Büküm

NL 17001  
Ek Birleşirme Aparatı



NL 17001  
Motorlu  
Sahne Perdeleri  
Takımı



NL 17200  
Motorlu

# NL 17200

Winter Garden  
Kış Bahçesi



**MOSEL®**







# NL 1001

Yanmaz, Antibakteriyel ve Su Geçirmez Hastane Perdeleri



Waterproof



ANTİMİKROBİYEL

CERTIFICATES

- IMO A 471
- B1
- BS 5867
- CLASSE UNO
- NFPA 701



Desing: NL 1000  
Color: 001  
width: 280±%3cm  
weight: 295±5gsm  
%100 Fireproof Polyester &Waterproof

NL 1001  
Yanmaz Perdeler

NL 1001  
Color 001

NL 1001  
Color 002

NL 1001  
Color 003

NL 1001  
Color 004

NL 1001  
Color 005

NL 1001  
Color 006

NL 1001  
Color 007

Desing: NL 1000  
Color: 002  
width: 280±%3cm  
weight: 295±5gsm  
%100 Fireproof Polyester &Waterproof

## Renk Varyantları

NL 1003

Desing: NL 1000  
Color: 003  
width: 280±%3cm  
weight: 295±5gsm  
%100 Fireproof Polyester &Waterproof

NL 1004

NL 1005

Desing: NL 1000  
Color: 004  
width: 280±%3cm  
weight: 295±5gsm  
%100 Fireproof Polyester &Waterproof

NL 1001

NL 1008

Desing: NL 1000  
Color: 005  
width: 280±%3cm  
weight: 295±5gsm  
%100 Fireproof Polyester &Waterproof

NL 1009

NL 1010

Desing: NL 1000  
Color: 006  
width: 280±%3cm  
weight: 295±5gsm  
%100 Fireproof Polyester &Waterproof

Su Geçirmez

Desing: NL 1000  
Color: 007  
width: 280±%3cm  
weight: 295±5gsm  
%100 Fireproof Polyester &Waterproof





Perde NL 1210  
Color: 003  
width: 280 ± 5gsm  
%100 Antibakteriyel Polyester 8Matenproof

Desing: NL 1210  
Color: 004  
width: 230 ± 5gsm  
weight: 60 ± 5gsm  
%100 Antibakteriyel Polye

NL 1210



Krem

Krem

Mavi

NL 1108

Antibakteriyel  
Sağlık Bakanlık  
Logolu





# NL 7001

Banyo Ray Sistemi







NL 4100  
Beyaz



NL 4100  
Gold

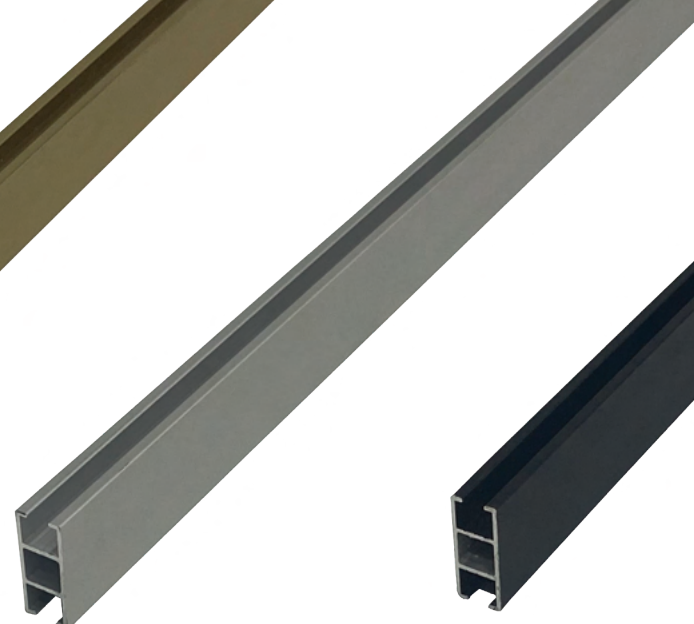

NL 4100  
Gümüş



NL 4100  
Siyah

NL 7100  
Yarım Daire  
Banyo Ray  
Sistemi

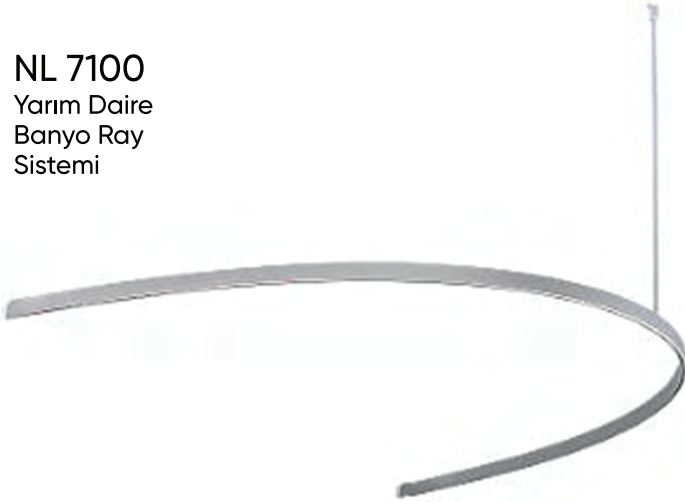

Oval  
Banyo Rayı



NL 7100  
Köşe 90x90  
Banyo Ray  
Sistemi



NL 7100  
20'lik  
Banyo Ray  
Sistemi







Gri



Lale

# NL 8001

## Banyo Boruları ve Perdesi



Sarmaşık Kahve



Beyaz



Kareli





**NL 8005**  
Alüminyum Banyo  
Borusu



**NL 8400**  
Teleskopik Krom Halkalı  
Banyo Borusu



**NL 8100**  
Beyaz Köşe 90 x 90 x 90



**NL 8100**  
Krom Köşe 90 x 90 x 90



**NL 8100**  
Mavi Köşe 90 x 90 x 90



**NL 8100**  
Pembe Köşe 90 x 90 x 90



**NL 8200**  
Krom Köşe 90 x 90 Oval



**NL 8200**  
Beyaz Köşe 90 x 90 Oval





Antibakteriyel Duş Perde Borusu ve Sağlık Bakanlığı Logolu



Köşe Büküm



NL 8004  
25 mm Paslanmaz Çelik  
İki Duvar Arası Banyo Borusu



NL 8004  
25 mm Paslanmaz Çelik  
Banyo Borusu Takım Görseli



NL 8004  
25 mm Paslanmaz Çelik  
Banyo Borusu



NL 8003  
22 mm Paslanmaz Çelik  
Teleskopik Banyo Borusu



NL 8300  
Teleskopik  
Banyo Borusu



NL 8300  
Teleskopik  
Banyo Borusu  
2 M



NL 8300  
Teleskopik  
Banyo Borusu  
3 M



NL 8300  
Teleskopik Eko  
Banyo Borusu  
2 M





NL 18001

Ahşap  
Rustikler





NL 18100  
Ahşap Duvar Flanşı

NL 18100  
Serisi



NL 18100  
Ahşap Halka



NL 18100  
Ahşap Renso



NL 18100  
Ahşap Rustik Rayı



NL 18100  
Akça Ağaç



NL 18100  
Beyaz



NL 18100  
Ceviz



NL 18100  
Gold



NL 18100  
Gümüş



NL 18100  
Kiraz



NL 18100  
Meşe



NL 18100  
Siyah





NL 18200  
Akça Ağaç



NL 18200  
Beyaz



NL 18200  
Ceviz



NL 18200  
Gold



NL 18200  
Kiraz



NL 18200  
Gümüş



NL 18200  
Meşe



NL 18200  
Siyah





NL 18300  
Akça Ağaç



NL 18300  
Beyaz



NL 18300  
Ceviz



NL 18300  
Gold



NL 18300  
Kiraz



NL 18300  
Gümüş



NL 18300  
Meşe



NL 18300  
Siyah



NL 25001

Alüminyum  
Metal Rustik





NL 25100  
Gold



NL 9080  
Gold Ray

NL 25100  
Gümüş



NL 9060  
Gümüş Ray

NL 25100  
İnoks



NL 30050  
İnoks Ray

NL 25100  
Siyah



NL 30050  
Siyah Ray



NL 25100  
Renso

NL 25100  
Kol Bağı





NL 25200  
Gold



NL 9080  
Gold Ray

NL 25200  
Gümüş



NL 9060  
Gümüş Ray

NL 25200  
İnoks



NL 30050  
İnoks Ray

NL 25200  
Siyah



NL 30050  
Siyah Ray

NL 25200  
Renso



NL 25200  
Kol Bağı





NL 9080  
Gold Ray

NL 25300  
Gold



NL 9060  
Gümüş Ray

NL 25300  
Gümüş



NL 30050  
İnkoks Ray

NL 25300  
İnkoks



NL 30050  
Siyah Ray

NL 25300  
Siyah



NL 25300  
Kol Bağı



NL 25300  
Renso



NL 30001

Alüminyum  
Metal Rustik



Renso





NL 30100  
Beyaz



NL 30100  
Gold



NL 30100  
İnoks



NL 30100  
Siyah

NL 30001  
Oval Büküm



NL 30050  
Beyaz Ray



NL 30500  
Gri Ray



NL 30500  
Gold Ray

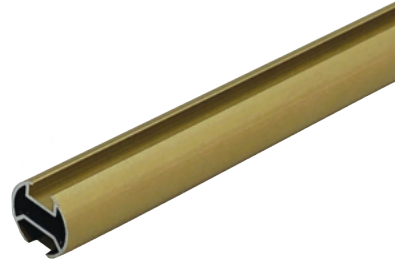

NL 30500  
Siyah Ray



NL 30500  
İnoks Ray



Kademeli  
Kapsül

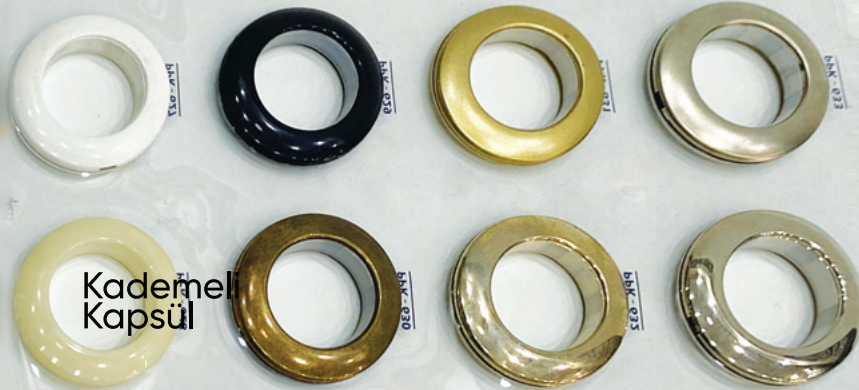

Rustik  
Halkası  
Siyah





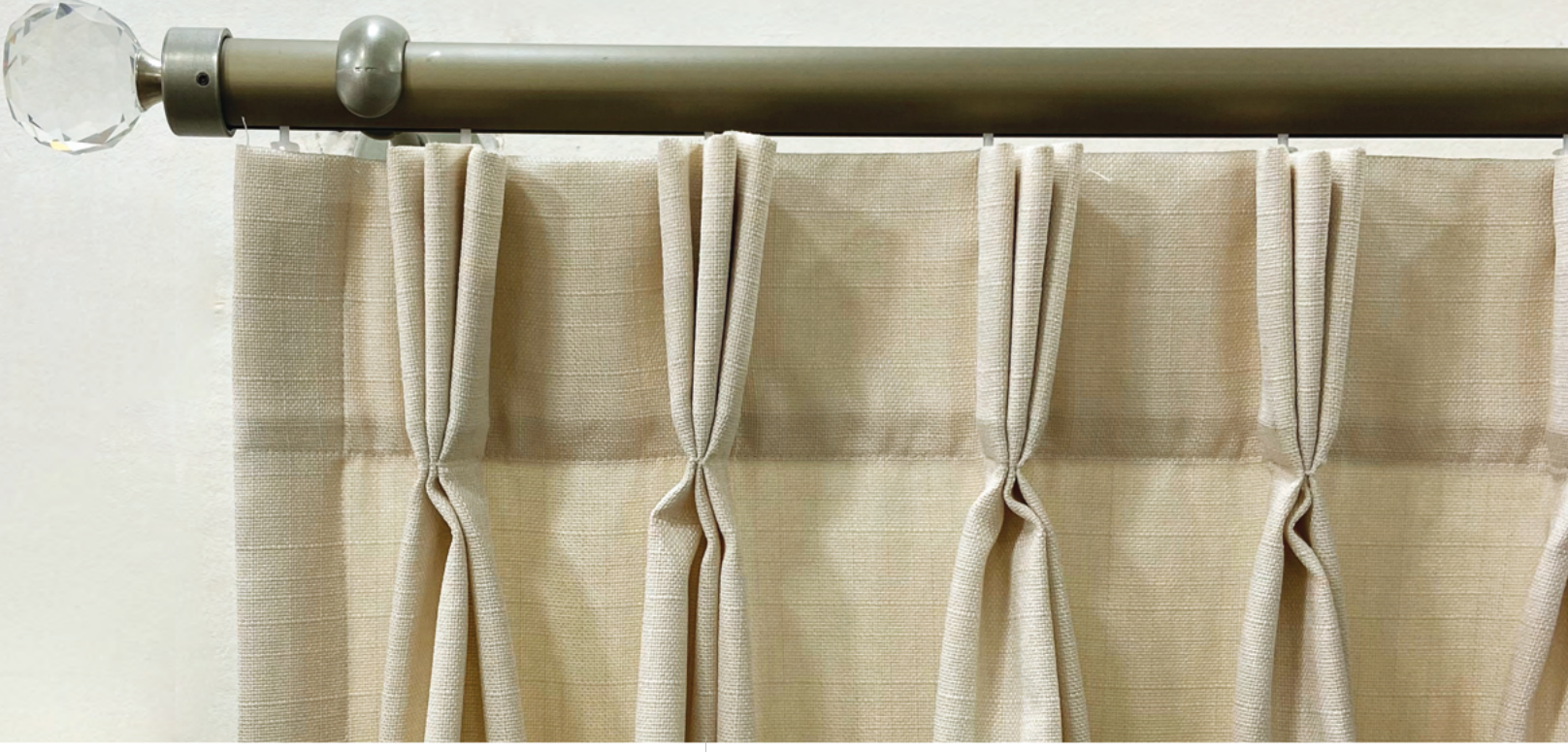

NL 30200  
Beyaz



NL 30050  
Beyaz Ray

NL 30200  
Gold



NL 30050  
Gold Ray

NL 30200  
İnoks



NL 30050  
İnoks Ray

NL 30200  
Siyah



NL 30050  
Siyah Ray



NL 30300  
Beyaz



NL 30300  
Gold



NL 30300  
Gümüş



NL 30300  
İnoks



NL 30300  
Siyah







NL 30400  
Beyaz



NL 30400  
Gold



NL 30400  
Gümüş



NL 30400  
İnkoks



NL 30400  
Siyah





NL 30600  
Gold Kol Bağı



NL 30600  
Gümüş Kol Bağı

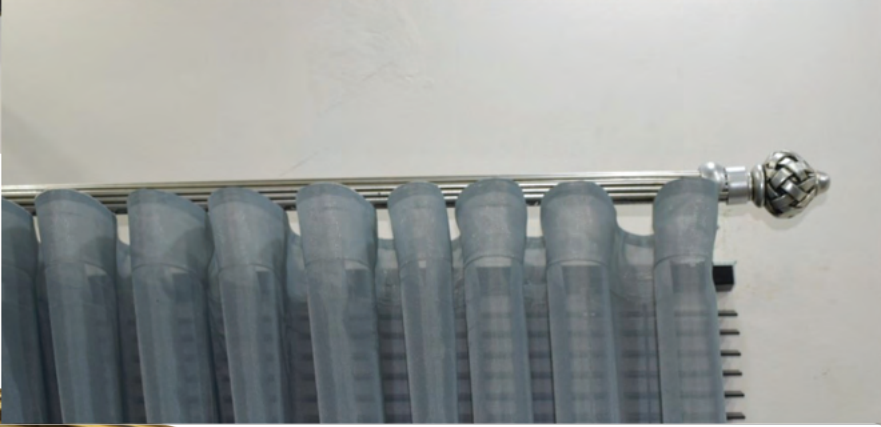

NL 30600  
Gümüş Renso



NL 30600  
Gold



NL 30600  
Gümüş



NL 30500  
Gold Kol Bağı

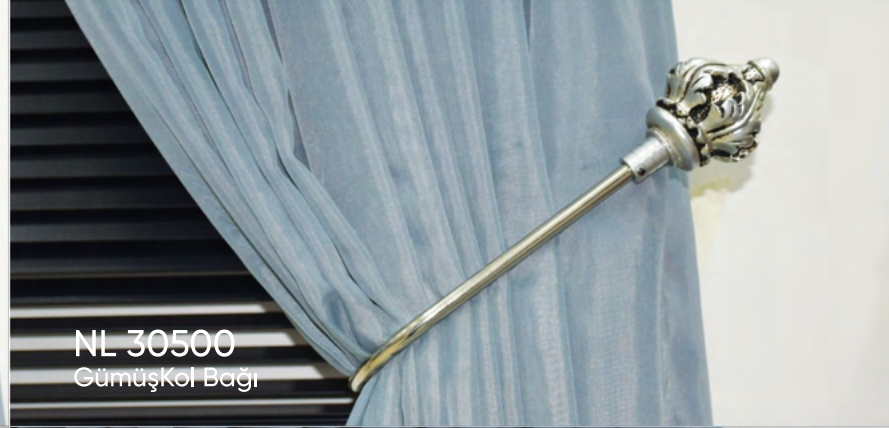

NL 30500  
Gümüş Kol Bağı



NL 30500  
Gold

NL 30500  
Gümüş





# NL 9001

Paslanmaz Metal  
Çelik Rustikler





# NL 9100

Paslanmaz Çelik  
Rustik Mat 16 mm



NL 9100



NL 9060  
Halka



NL 9050  
Ray



NL 9100  
Kol Bağı



NL 9100  
Renso

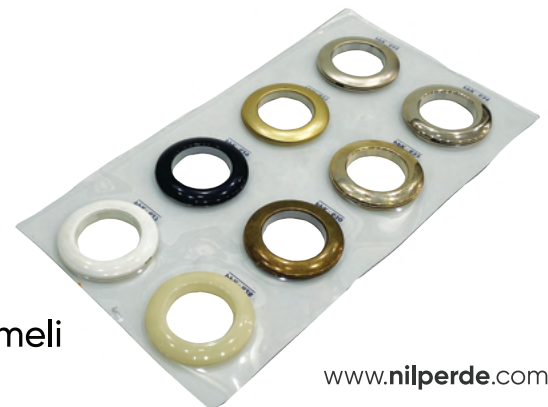

Kademeli  
Kapsül



# NL 9101

Paslanmaz Çelik  
Rustik Mat 16 mm



## NL 9050

Ray



## NL 9101



## NL 9060



## Kademeli Kapsül







# NL 9200

Paslanmaz Çelik  
Rustik Mat 25 mm



NL 9200  
Rustik



NL 9060  
Halka



NL 9100  
Kol Bağı



NL 9050  
Ray



NL 9200  
Renso

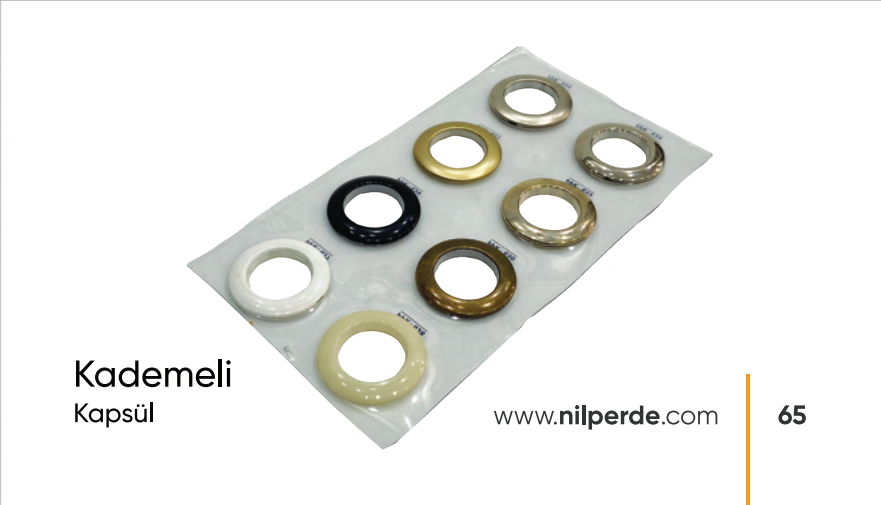

Kademeli  
Kapsül





# NL 9302

Paslanmaz Çelik  
Rustik 22 mm



NL 9302  
Rustik



NL 9060



NL 9302  
Kol Bağı



NL 9050  
Ray



NL 9302  
Renso



Kademeli  
Kapsül



# NL 9300

Paslanmaz Çelik  
Rustik 22 mm



NL 9300  
Rustik



NL 9060  
Halka



NL 9300  
Kol Bağı



NL 9050  
Ray



NL 9300  
Renso



Kademeli  
Kapsül







**NL 9301**  
Paslanmaz Çelik  
Rustik 22 mm



**NL 9301**  
Rustik



**NL 9060**  
Halka



**NL 9301**  
Kol Bağı



**NL 9050**  
Ray



**NL 9301**  
Kors



**Kademeli**  
Kapsül





# NL 9400

Paslanmaz Çelik  
Mat Rustik 25 mm



NL 9400  
Kol Bağı



NL 9050  
Ray



NL 9060



NL 9400  
Renso



Kademeli  
Kapsül



# NL 9401

Paslanmaz Çelik  
Mat Rustik 25 mm

NL 9050  
Ray



NL 9060



NL 9401  
Kol Bağı



NL 9401  
Rustik



NL 9401  
Renso



Kademeli  
Kapsül







# NL 9402

Paslanmaz Çelik  
Mat Rustik 25 mm



NL 9050  
Ray



NL 9060



NL 9402  
Kol Bağı



NL 9402  
Rustik



NL 9402  
Renso



Kademeli  
Kapsül









# NL 24001

Ahşap Jaluzi





NL 24300  
Ahşap Jaluzi  
50 mm

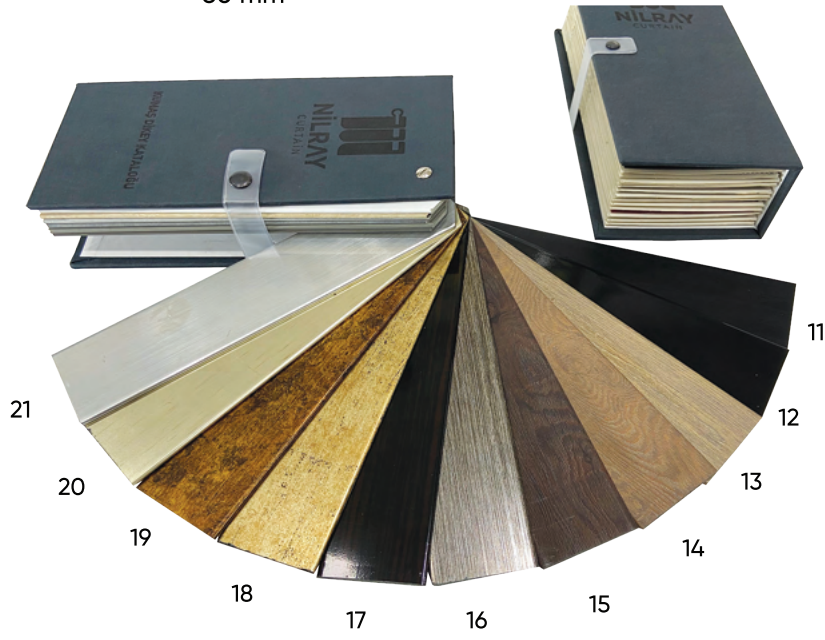

NL 24200  
Ahşap Jaluzi  
25 mm Poly Wood

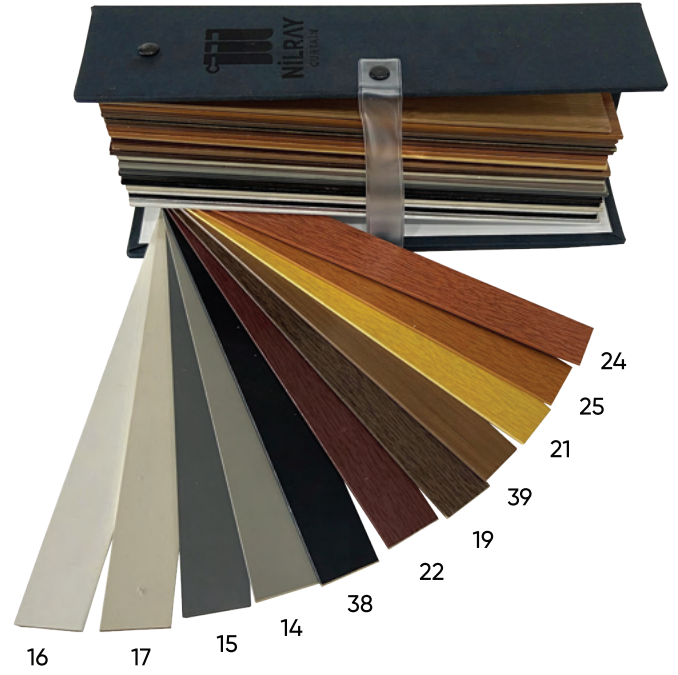

NL 24100  
Ahşap Jaluzi  
50 mm

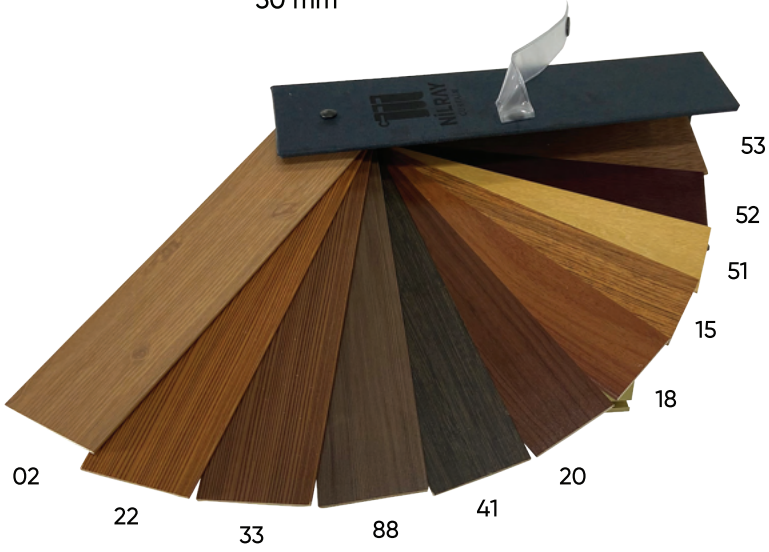

NL 24100  
Ahşap Jaluzi  
50 mm

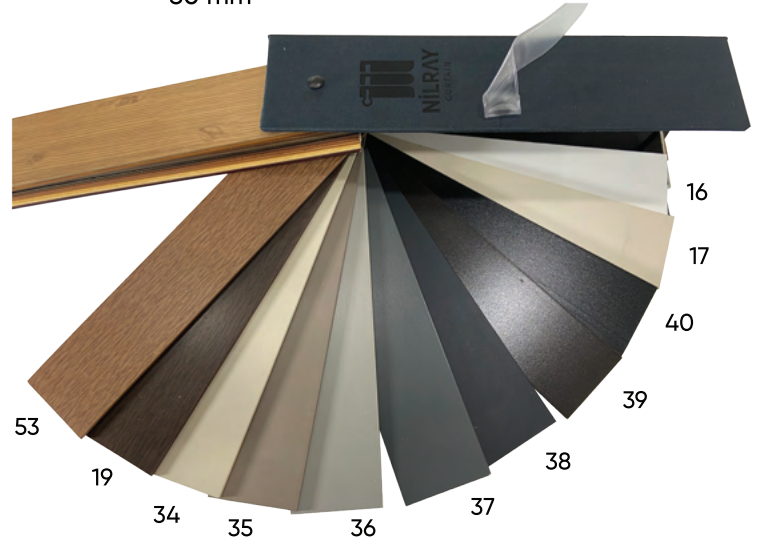

NL 24100  
Ahşap Jaluzi  
50 mm

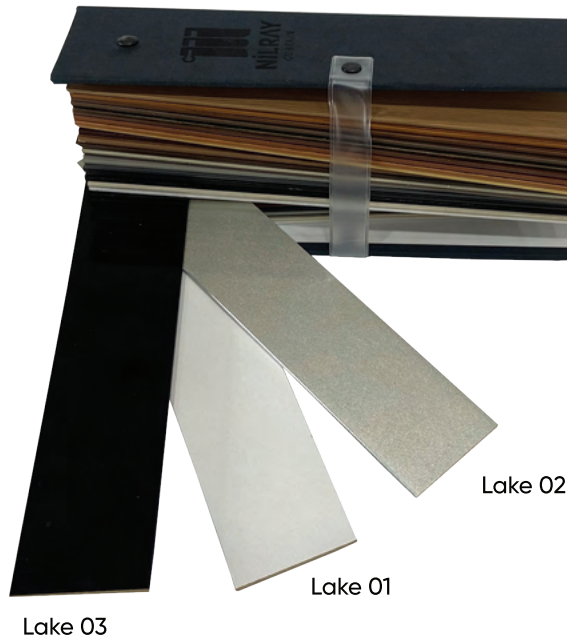





# NL 26001

Metal Jaluzi







NL 26200 - 1  
25 mm  
MetalJaluzi



NL 26200 - 2  
25 mm  
MetalJaluzi



NL 26200 - 3  
25 mm  
MetalJaluzi



NL 26300  
50 mm  
MetalJaluzi





# NL 23001

Pvc Perde ve Kumař



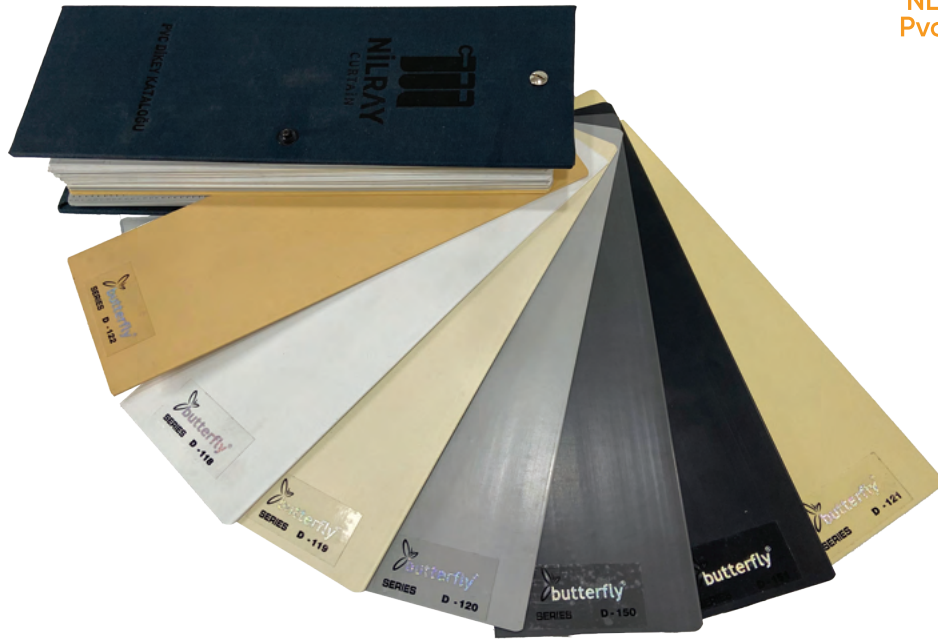

NL 23100 - 1  
Pvc Dikey  
Perde

Gri Antrasit Siyah

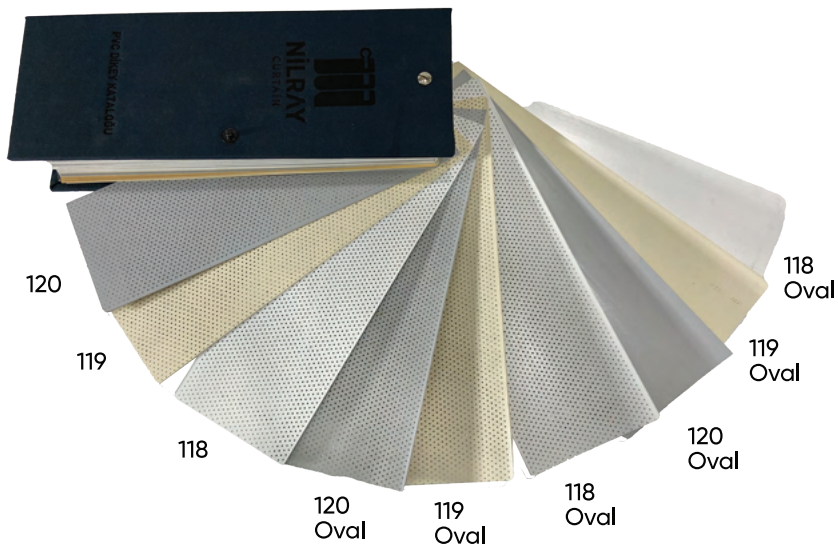

NL 23100 - 2  
Pvc Dikey  
Perde

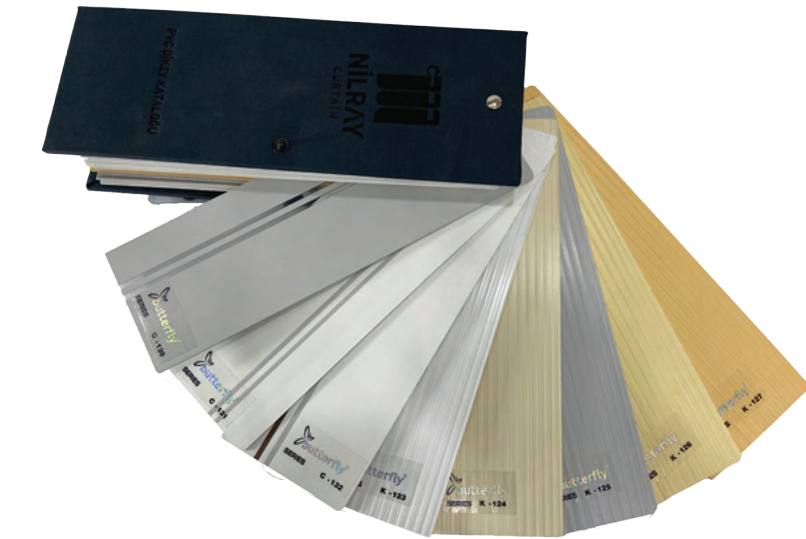

NL 23100 - 3  
Pvc Dikey  
Perde

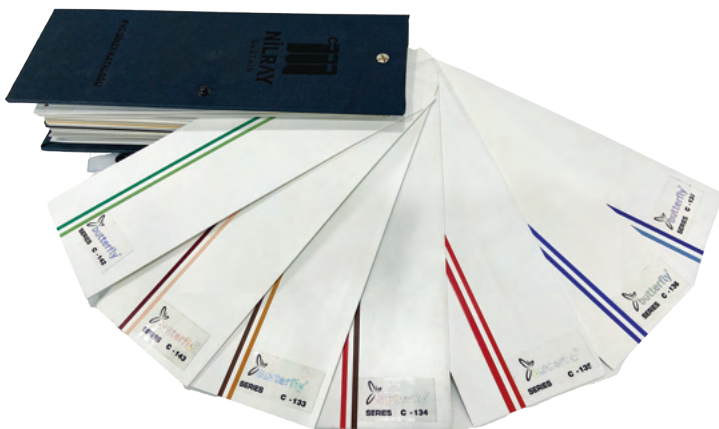

NL 23100 - 4  
Pvc Dikey  
Perde

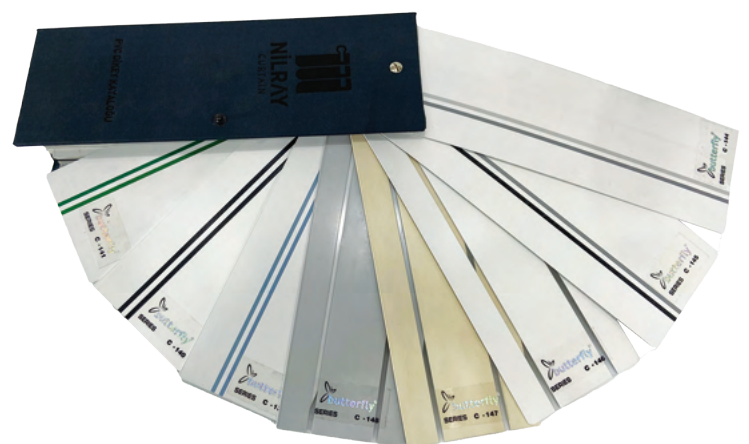

NL 23100 - 5  
Pvc Dikey  
Perde



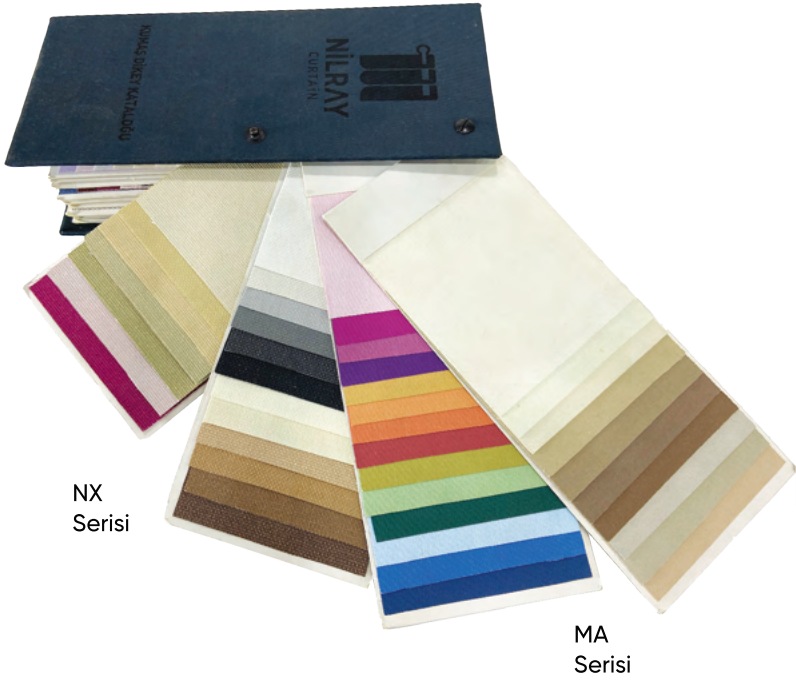

NX  
Serisi

MA  
Serisi

NL 23200 - 1  
Kumaş  
Dikey Perde

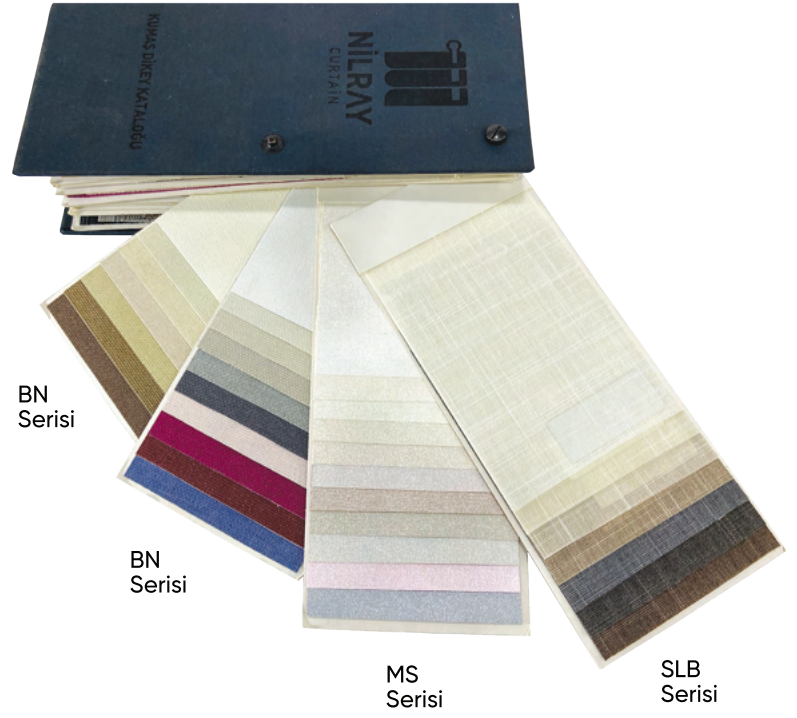

BN  
Serisi

BN  
Serisi

MS  
Serisi

SLB  
Serisi

NL 23200 - 2  
Kumaş  
Dikey Perde

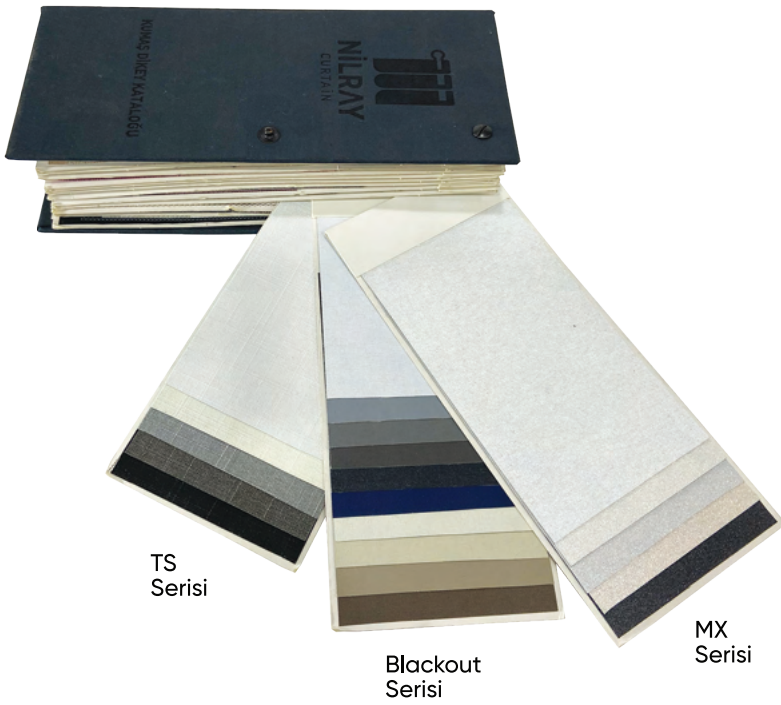

TS  
Serisi

Blackout  
Serisi

MX  
Serisi

NL 23200 - 3  
Kumaş Dikey  
Perde

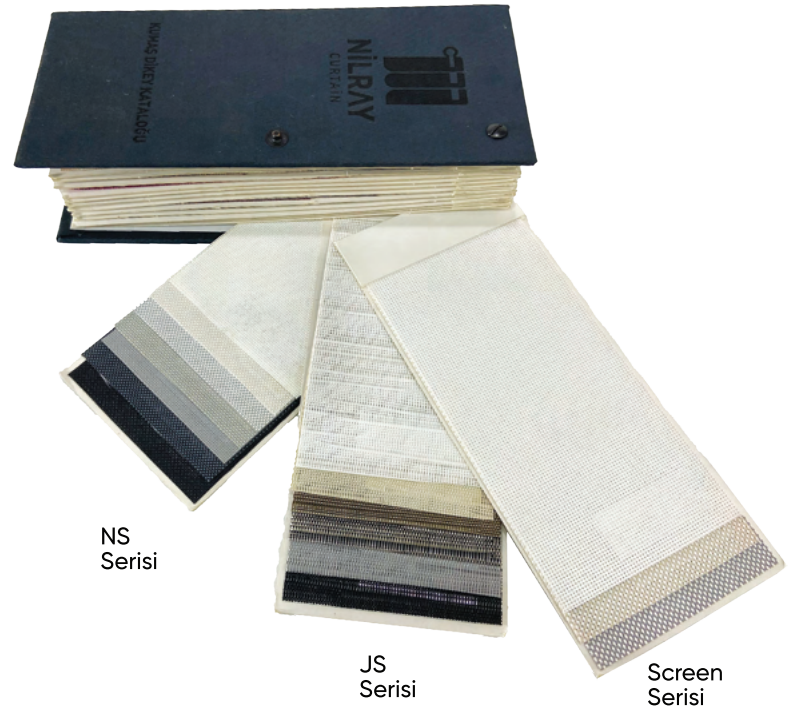

NS  
Serisi

JS  
Serisi

Screen  
Serisi

NL 23200 - 4  
Kumaş Dikey  
Perde



Lorem ipsum

# NL 22001

Stor ve Zebra  
Perdeler





NL 22100  
Blackout  
Serisi

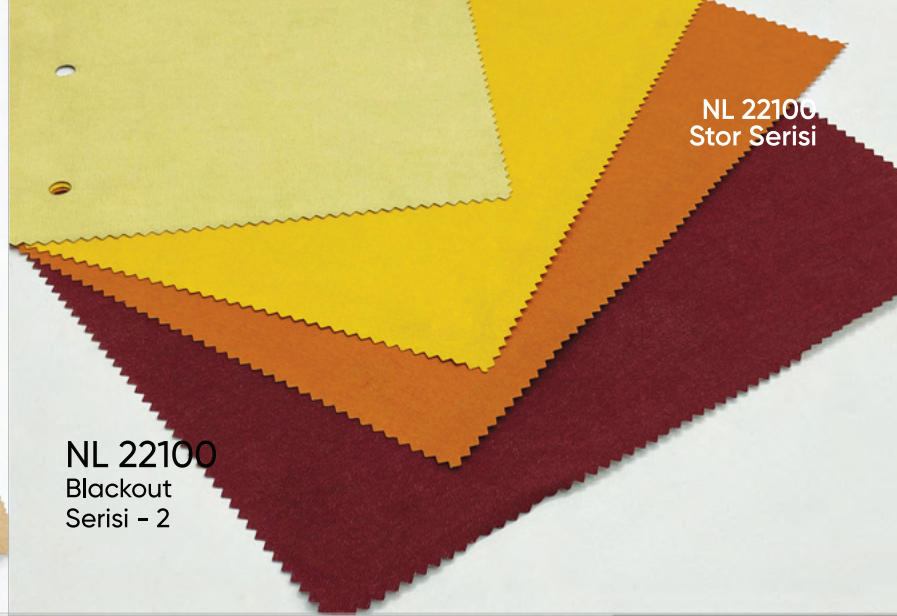

NL 22100  
Stor Serisi

NL 22100  
Blackout  
Serisi - 2



NL 22100  
Blackout  
Serisi - 3

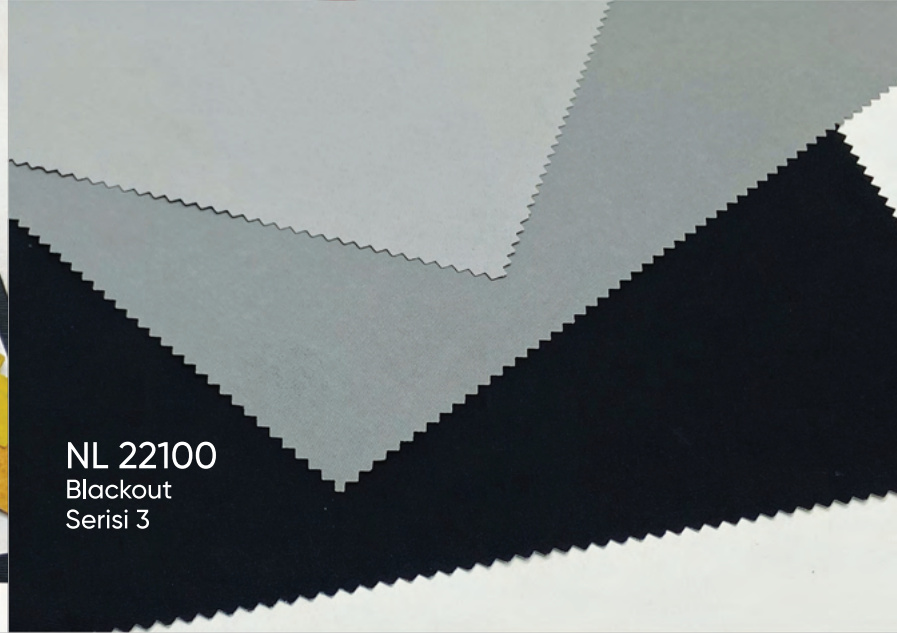

NL 22100  
Blackout  
Serisi 3



NL 22100  
Nilo  
Desenler



NL 22100

NL 22100 Sunscreen



NL 22100 Sunscreen- 2

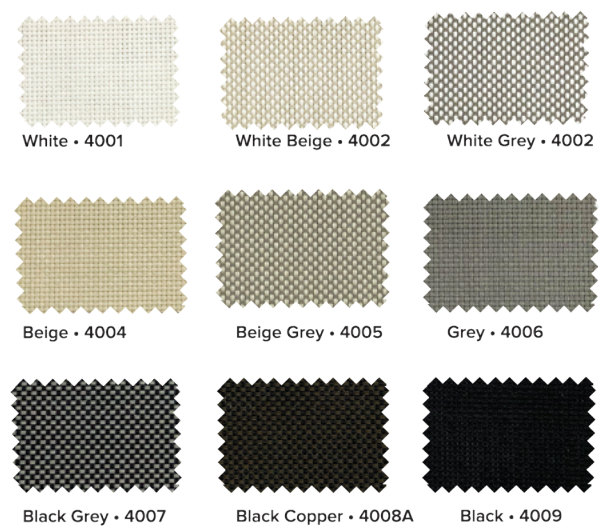



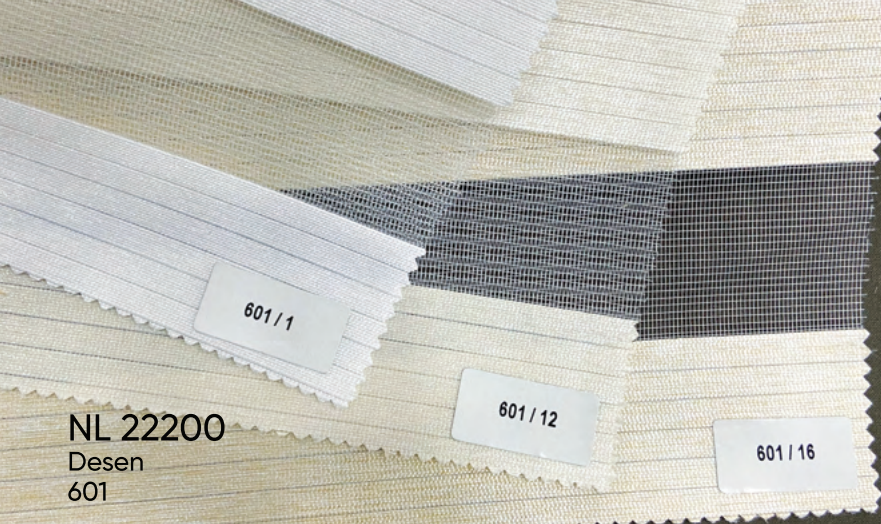

NL 22200  
Desen  
601



NL 22200  
Zebra Serisi

NL 22200  
Desen  
614 - 1



NL 22200  
Desen  
614 - 2



NL 22200  
Desen  
629

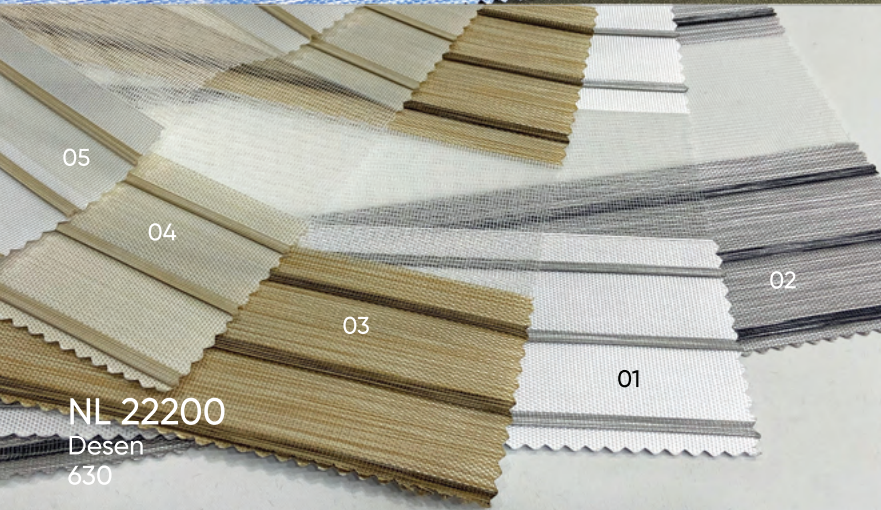

NL 22200  
Desen  
630

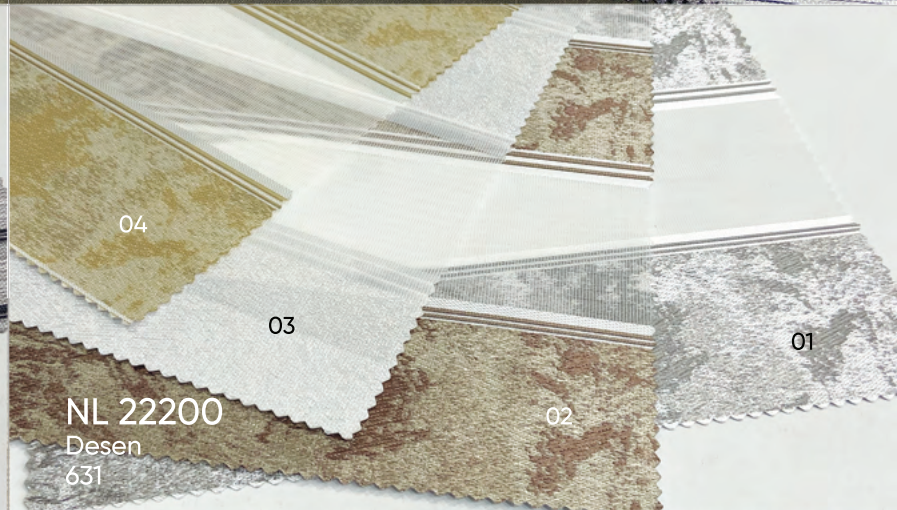

NL 22200  
Desen  
631



NL 22200  
Desen  
10687 - 1



NL 22200  
Desen  
10687 - 2



NL 22200  
Desen  
10694



NL 22200  
Desen  
10928





# NL 27001

Plise Perdeler



Nil Perde  
066



Plise





PL 010  
Sarı

PL 001  
Kahve

PL 001  
Gri

PL 001  
Kırmızı

PL 001  
Beyaz

PL 001  
Siyah

## İP PERDELER

PL 002  
Bej

PL 002  
Bordo

PL 001  
Gold

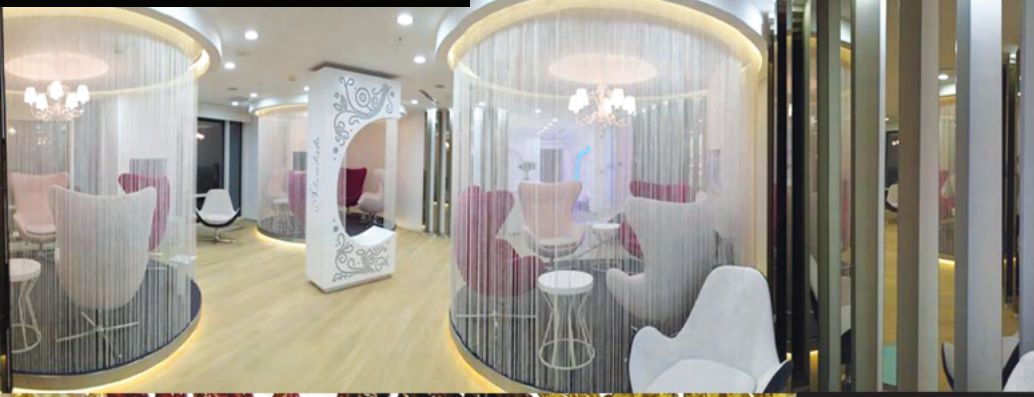

Bukle 09  
Sarı  
A.S.

Bukle 09  
Sarı  
A.S.

Bukle 01  
Gri  
G.S.

Bukle 01  
Kahve  
B.S.

Bukle 01  
Siyah  
G.S.

Bukle 02  
Kırmızı  
G.S.

Bukle 01  
Beyaz  
G.S.

Bukle  
Sarı  
G.S.





**NL 21100**  
Alüminyum Gold  
Briz Çubuğu 8 mm



**NL 21100**  
Alüminyum Krom  
Briz Çubuğu 8 mm



**NL 21100**  
Beyaz Ayarlanabilir  
Briz Çubuğu



**NL 21100**  
Pirinç Gold Briz Çubuğu ve  
Başlığı 10 mm

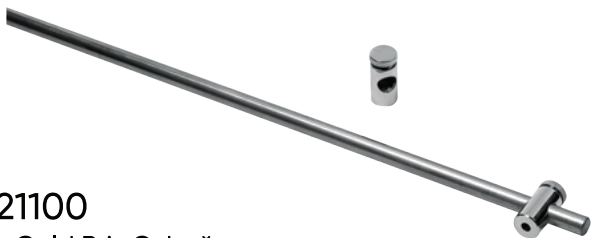

**NL 21100**  
Pirinç Krom Briz Çubuğu ve  
Başlığı 10 mm

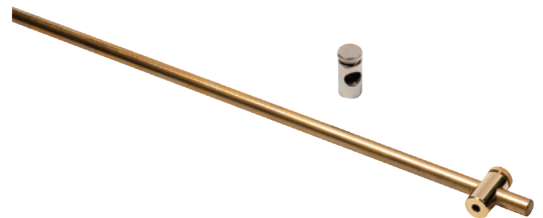





# PERDE

Aksesuarları





Yan Baęlama  
Broçol  
05



Yan Baęlama  
Broçol  
08



Yan Baęlama  
Broçol  
11



Yan Baęlama  
Broçol  
13





Beyaz C Halka

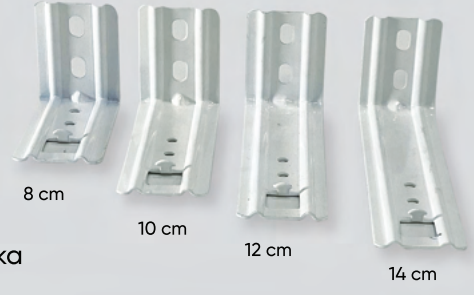

Beyaz L Halka

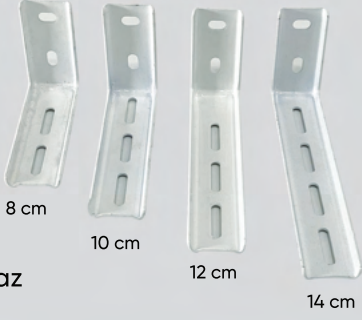

Dar L Ayak Beyaz



Dikmeli Rulet Makina



El Dikmeli Rulet



Final



Geçmeli Rulet

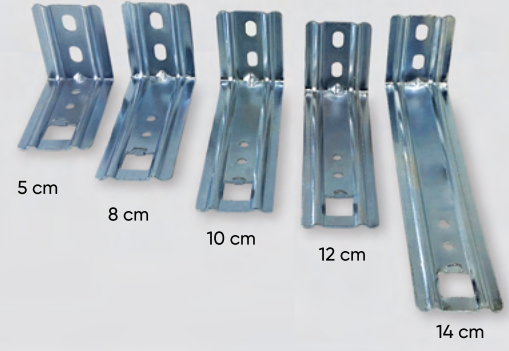

Gri L Ayak



Halka Tutacağı



Kare Rulet



Kelebek Final



Kilitli Halka



Krem C Halka



Krom C Halka



Şeffaf C Halka



Mavi C Halka



Metal Kancalı Rulet



Oryantal Makara



Oval Kancalı Rulet



Oval Rulet



Paslanmaz C Halka



Pembe C Halka



Pirinç Perde Kapsülü



Rustik Halkası Gold







Rustik Halkası Kahve



Rustik Halkası Ruleti Beyaz

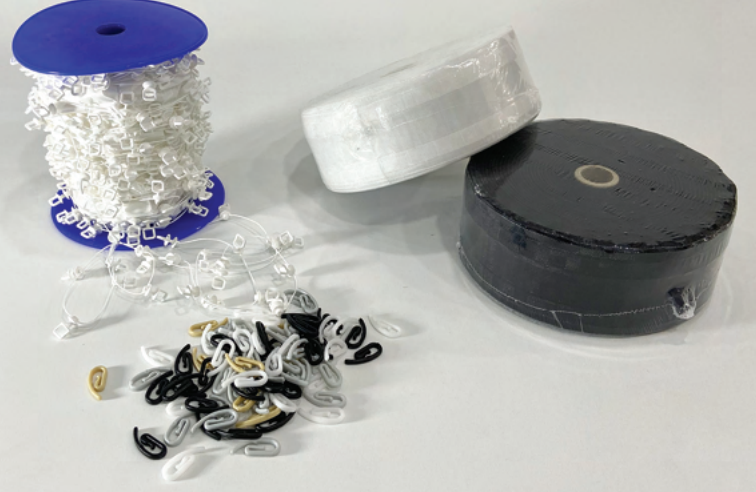

S pile İpli Rulet



Rustik Halkası Ruleti Krem



Rustik Halkası Ruleti Meşe



Rustik Halkası Ruleti Şeffaf



Rustik Halkası Ruleti Siyah



Rustik Halkası Şeffaf



Rustik Halkası Gri



Rustik Halkası Siyah



Rustik Halkası Gold





S Salyangoz



Salyangoz



Tirajlı Rulet



Stor Montaj  
Aparatı



Tekerlekli Rulet



Tirajlı Yuvarlak  
Rulet



Z iğne





**EKOTEKS**

**TÜRKAK**  
TÜRK AKREDITASYON KURUMU  
TURKISH ACCREDITATION AGENCY  
tarafından akredite edilmiştir

**EKOTEKS LABORATUVAR ve GÖZETİM HİZMETLERİ A.Ş.**  
Esenyurt Fınıklıyolu Bulvarı No:29/34325 Avcılar  
İstanbul/ TÜRKİYE



AB-0583-T  
15015402-  
img  
04-15

**TEST REPORT**  
DENET RAPORU

---

**Customer name:** NIL PERDE SİSTEMLERİ - MURAT SULAK  
**Address:** Fatih Sultan Cad. No:45/B BEYOĞLU/ İSTANBUL  
**Buyer name:** NIL PERDE SİSTEMLERİ - MURAT SULAK  
**Contact Person:** MURAT SULAK  
**Order No:** -  
**Article No:** NIL - PERDEV - 01  
**Name and identity of test item:** One sample of cream woven fabric. (Cream)  
**The date of receipt of test item:** 02.04.2015  
**Re-submitted/re-confirmation date:** -  
**Date of test:** 02.04.2015-13.04.2015  
**Remarks:** -  
**Sampling:** The results given in this report belong to the received sample by vendor.  
**End-Use:** Home Textile/ Hospital Curtain  
**Care Label:**   
**Number of pages of the report:** 4

The Turkish Accreditation Agency (TÜRKAK) is signatory to the multilateral agreements of the European co-operation for the Accreditation (EA) and of the International Laboratory Accreditation (ILAC) for the Mutual recognition of test reports.

The test and/or measurement results, the uncertainties (if applicable) with confidence probability and test methods are given on the following pages which are part of this report.

<b>Seal</b>	<b>Date</b>	<b>Person in charge of test</b>	<b>Head of Testing Laboratory</b>
	13.04.2015	N. FİSİM EROL	Sevim A. RAZAK

This report shall not be reproduced other than in full except with the permission of the laboratory.  
Testing reports without signature and seal are not valid.



**EKOTEKS**

**REPORT**

1140085

**TEST RESULTS**

**ANTIBACTERIAL ACTIVITY : ASTM E2149:2010**

Results (log.cfu/sample)	After incubation (37° C)			
	1h	6h	18h	24h <sup>(1)</sup>
Contact Time (0h)				
5.07				

(1) No bacteria growth was observed after 24 hour.

Bactericidal activity	Result	Requirement
(Sample) Reduction (%), for 24h	% 99.9 Effective	-

Microorganism	Methicilin Resistance
Staphylococcus aureus ( ATCC 33592) (Gram(+))	
Bacterial concentration ( kob/ml )	2.3 x10 <sup>7</sup>
Inoculum volume	0.05 ml
Size of Sample	1g
Number of washing	-
Washing method	-
Incubation time	24h

Page 2 of 2

EKOTEKS LABORATUVAR VE GÖZETİM HİZMETLERİ LTD. ŞTİ.  
Esenyurt Fınıklıyolu Bulvarı No: 29/34325 Avcılar/İstanbul/ TÜRKİYE  
Tic. Sic. No: 272 476 71 86 Şub. Sic. No: 272 486 26 31  
E-mail: info@ekoteks.com www.ekoteks.com







**CERTIFICATE**

**NİL MEKANİK PERDE SİSTEMLERİ  
DEKORASYON SANAYİ VE TİCARET  
LİMİTED ŞİRKETİ**

FETHİTEPE MAH. FATİH SULTAN CAD. NO:45 B  
BEYOĞLU / İSTANBUL / TÜRKİYE

Has been assessed and found to Comply with the Requirements of:  
Denetlenmiş ve aşağıdaki standardın gerekliliklerine uygunluğu görülmüştür:

**ISO 9001:2015**

The Quality Management System is applicable to:  
Kalite Yönetim Sistemi:

MANUFACTURING, MARKETING, IMPORT AND EXPORT OF CURTAIN SYSTEMS  
(MECHANICAL SYSTEMS, FABRIC CURTAIN AND CURTAIN RAIL SYSTEMS)

PERDE SİSTEMLERİ ÜRETİM, PAZARLAMA, İTHALAT VE İHRACATI  
(MEKANİK SİSTEMLER, KUMAŞ PERDE VE PERDE RAY SİSTEMLERİ)

Certificate Number: QMS-0104486 Belge Numarası: QMS-0104486	Initial Certification Date: 06.05.2022 İlk Belgeleştirme Tarihi: 06.05.2022
Certification Period: 3 Years Belgeleştirme Periyodu: 3 Yıl	Certificate Validity Date: 05.05.2023 Belge Geçerlilik Tarihi: 05.05.2023



IQR ULUSLARARASI BELGELENDİRME HİZMETLERİ LTD.ŞTİ.  
Büyükdere Mah. Kocayusuçu Dk. No:2 Arslan Han Plaza K:3 Nispetiye / BEURSA  
Tel: +90224 200 00 86 Faks: +90224 200 41 13 www.iqrnet.com e-posta: info@iqrnet.com



T.C.  
TÜRK PATENT ve MARKA KURUMU

**MARKA TESCİL BELGESİ**

Marka No : 2019 106617 - Ticaret - Hizmet



**Marka Sahibi :** NİL MEKANİK PERDE SİSTEMLERİ DEK. SAN. VE TİC. LTD.ŞTİ  
TÜRKİYE CUMHURİYETİ  
Fatih Sultan Cad. No:45/B Beyoğlu/İSTANBUL, Beyoğlu İlçe/İstanbul

**Emtia :** 06 , 20 , 35  
İhtiktedir.



İşbu Marka 30/10/2019 tarihinden itibaren ON YIL süreyle  
25/10/2021 tarihinde tescil edilmiştir.



Prof. Dr. Halil ASAN  
Türk Patent ve Marka  
Kurumu Başkanı









TEST / ANALİZ ÇALIŞMASI:  
TEST / ANALYSIS:

Güç Tutuşurluk Burning behaviour following to NFPA 701				
Desen: Sağlık Bakanlığı				
NUMUNE SAMPLE	NM-19-208			
Kumaş test yönü Fabric Direction	Çoğu Warp	Ağı		
		Alevli döküntülerin zemine yanma süresi Burning time of dropping off material (s)	Kumaşın test sonu ağırlık kaybı Percent weight lost (%)	Alevli döküntülerin zemine yanma süresi Burning time of dropping off material (s)
Ölçüm No Measur No	Kumaşın test sonu ağırlık kaybı Percent weight lost (%)	Alevli döküntülerin zemine yanma süresi Burning time of dropping off material (s)	Kumaşın test sonu ağırlık kaybı Percent weight lost (%)	Alevli döküntülerin zemine yanma süresi Burning time of dropping off material (s)
1	5,9	0	7,0	0
2	9,5	0	10,9	0
3	8,0	0	10,1	0
4	16,6	0	10,4	0
5	11,4	0	9,7	0
6	10,4	0	9,3	0
7	7,1	0	11,9	0
8	8,3	0	8,2	0
9	8,7	0	6,8	0
10	7,0	0	10,5	0
Ortalama Average (%)	9,3	0	9,5	0
Standart sapma Standart deviation (S)	3,1		1,7	
Sonuç Conclusion	GEÇTİ PASS		GEÇTİ PASS	

ÇALIŞMAYI YÜRÜTEN  
Performed by  
Yunus SAVUCUONAYLAYAN  
Approved by  
Nurcan YEŞİLKÖYÜK  
Uygulama Laboratuvarı Yöneticisi  
Application Laboratory SupervisorOrganize Sanayii Bölgesi San. Cad. 4. Sk. No:2 18159 BURSA  
Tel: 0 224 528540 Faks: 0 224 2422877  
www.rudolf-duraner.com.tr

F.218.R1

Sayfa/Page 2 / 3

## TEST REPORT

Page 1 of 2

REPORT NUMBER : TURT140028421  
APPLICANT NAME : Nil Mekanik Perde Sist. Dek. San ve Tic. Ltd. Şti.  
ADDRESS : Fatih Sultan Cad No: 45/B Beyoğlu/İSTANBUL  
Attention : Murat SÜLAK info@nilperde.com

BUYER : ARMY&AIR FORCE EXCHANGE SERVICE  
SAMPLE DESCRIPTION : One sample of ecru woven fabric  
DATE IN : 26 February,2014 (13:48)  
DATE OUT : 11 March,2014  
FIBER COMPOSITION : Claimed to be 100% Polyester  
MODEL NO : SP68F  
FABRIC WEIGHT : Claimed to be 313.89 g/m<sup>2</sup>  
YOUR REFERENCE : SEPARATOR HOSPITAL CURTAIN

TEST	Sample
NFPA 701 - FIRE TESTS FOR FLAME PROPAGATION OF TEXTILES AND FILMS - METHOD 1(I)	NR

F = MEETS BUYER'S REQUIREMENT / F = DOES NOT MEET BUYER'S REQUIREMENT / NR = NO REQUIREMENT / SO=STILL CONTIGUES / N=NOT PERFORMED / NA = NOT APPLICABLE / L3 = LACK OF SAMPLE

The test results relate only to the items tested. The whole (and/or the part) of this test report shall not be reproduced and shall not be shared with third parties, nor to be used for PR activities without the written permission of INTERTEK Test-Hamilton A.S.

Çinar POLAT  
COORDINATORSinan ÖNCEL Customer Care  
Manager  
Özlem ÇAVUMİRZA Textile Laboratory  
ManagerIntertek Test Hizmetleri A.Ş.  
Merkez Mahallesi Sanayi Cad. No:23 Akatlar Plaza Yeşibosna 34197 - İSTANBUL / TURKEY  
Phone : +90 212 496 46 46 Fax : +90 212 452 99 55  
e-mail : labtest.turkey@intertek.com  
www.intertek.com.tr

**NİL PERDE**®



**NİLRAY**®  
CURTAIN









#### MERKEZ İMALAT

Adres: Fetihtepe Mah. Fatih Sultan Cad. No:45B 34440  
Okmeydanı -Beyoğlu / İSTANBUL-TURKEY

Santral Tel:

+90 212 250 70 42-43

+90 212 250 71 45

info@nilperde.com • pazarlama@nilperde.com

WHATSAPP SİPARİŞ HATTI: 0532 797 41 50 - 0533 813 14 66

#### ŞUBE İMALAT

Piyalepaşa Mah. Yılmaz Sokak No: 22 34440 Beyoğlu / İSTANBUL

#### ŞUBE İMALAT- 2

Zafer Mah. Özgürlük Cad. No: 50 49500 Bulanık /MUŞ

#### WEB SİTELERİMİZ

www.nilperde.com • ww.nilray.com